

VARIABLES DE LA ACTUACION

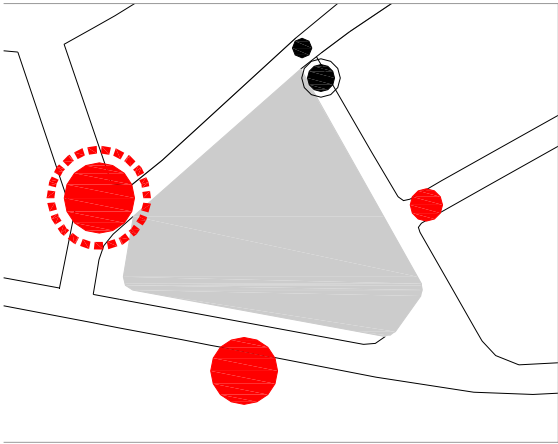

NODOS



VARIABLES DE LA ACTUACION

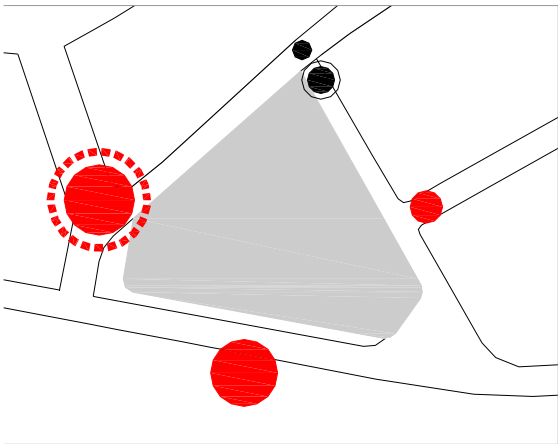

NODOS

+

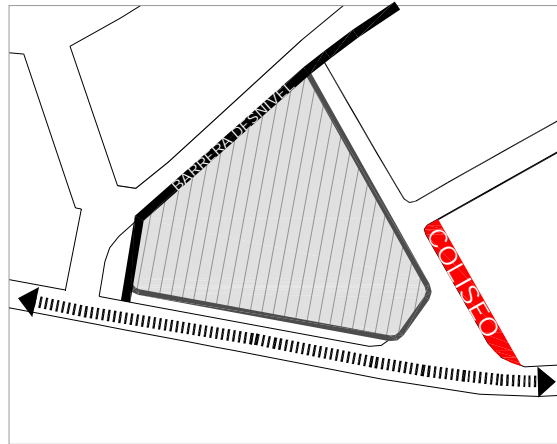

LÍMITES DEL SOLAR



VARIABLES DE LA ACTUACION

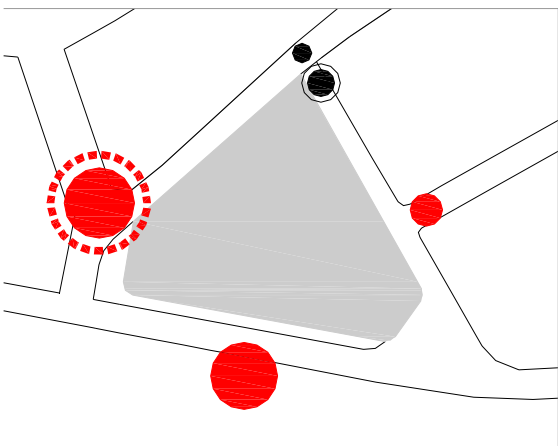

NODOS

+

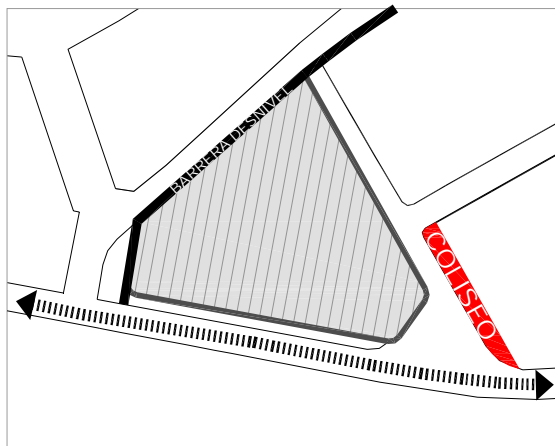

LÍMITES DEL SOLAR

⇒

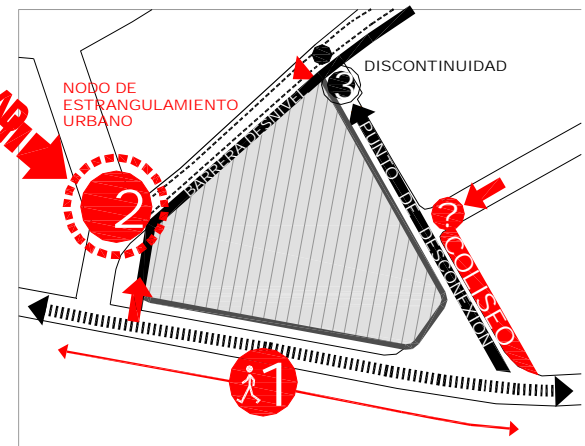

VARIABLES URBANAS



VARIABLES DE LA ACTUACION

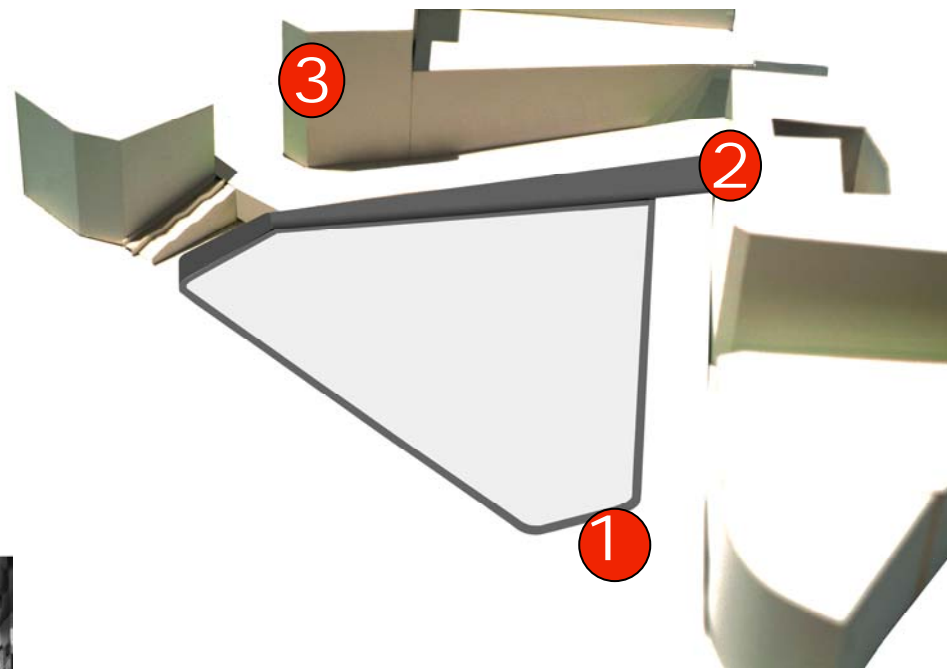
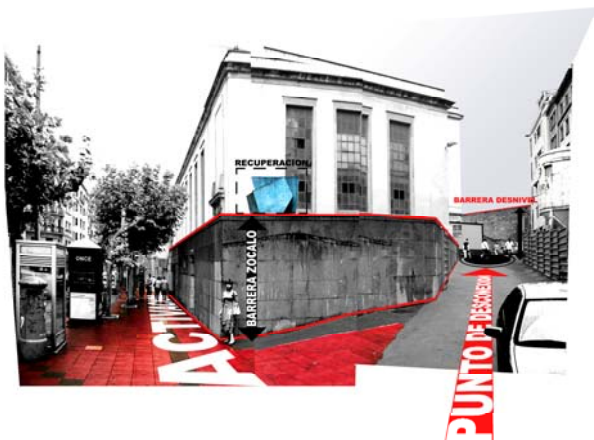

VARIABLES DE LA ACTUACION

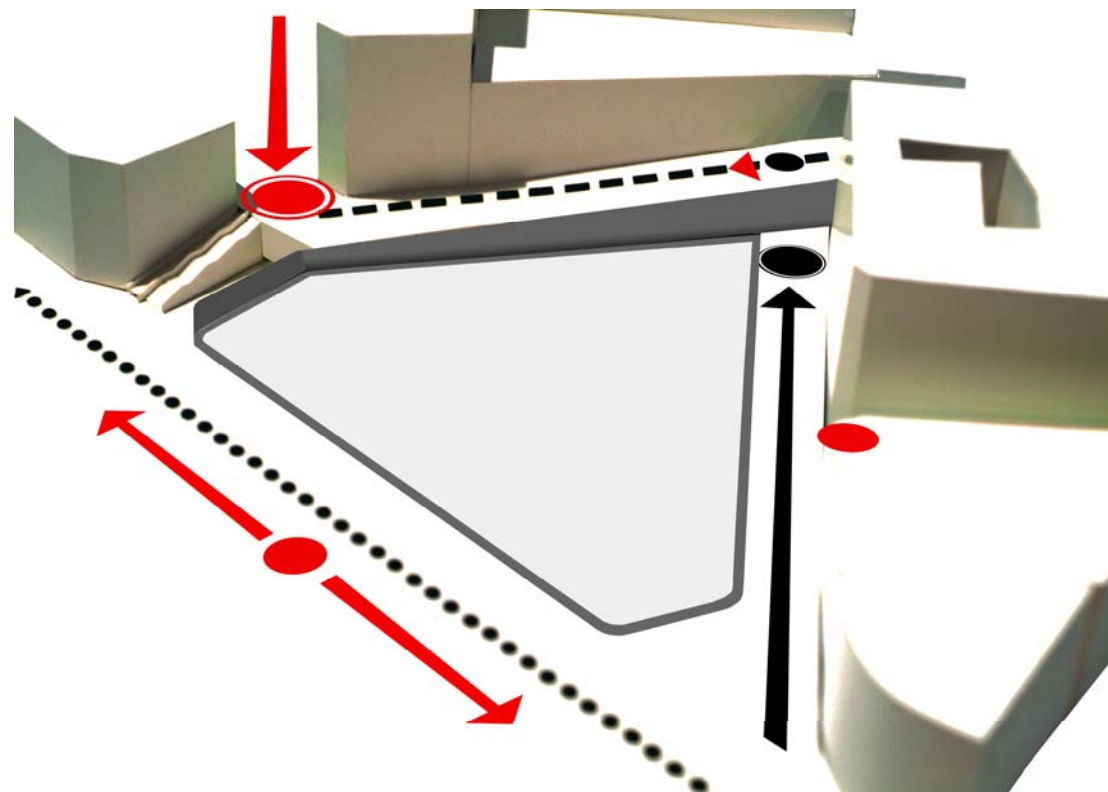
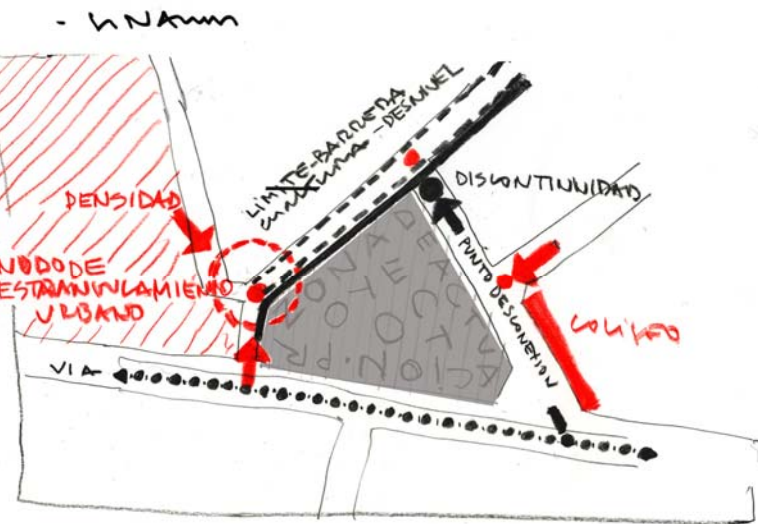

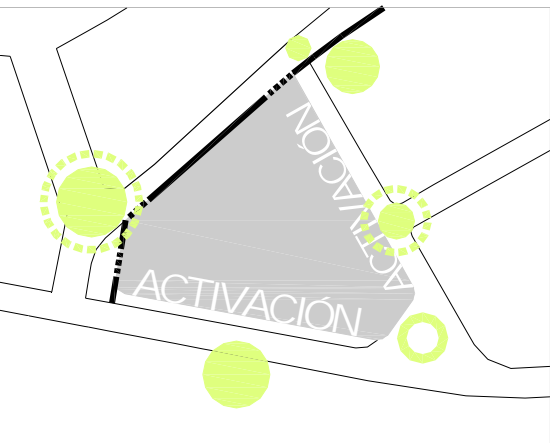
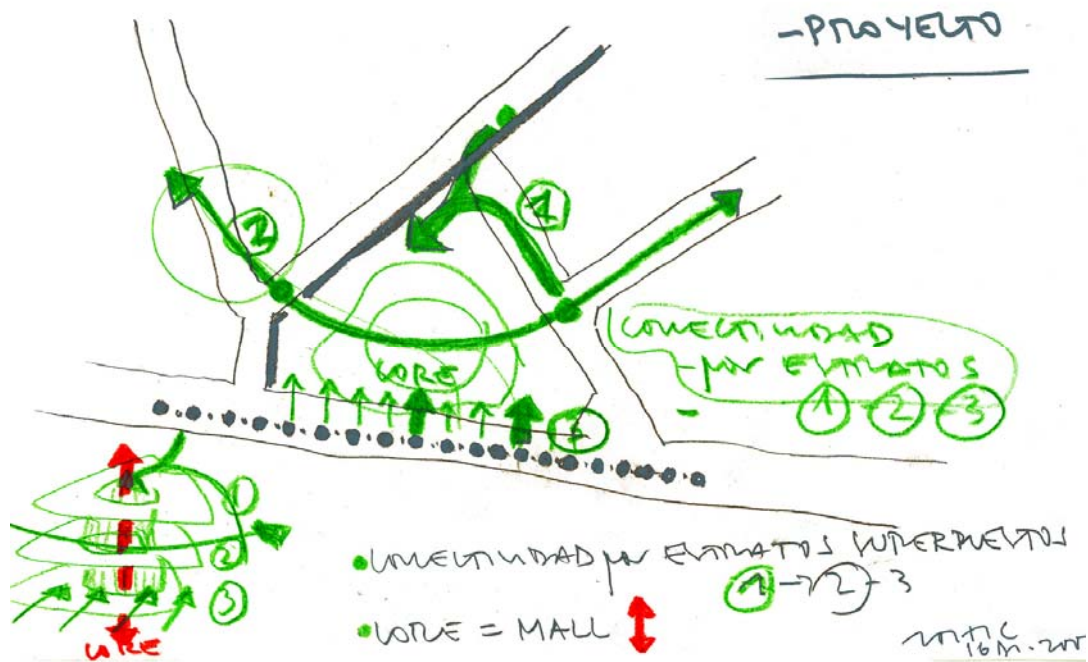

ACTIVACIÓN DE NODOS

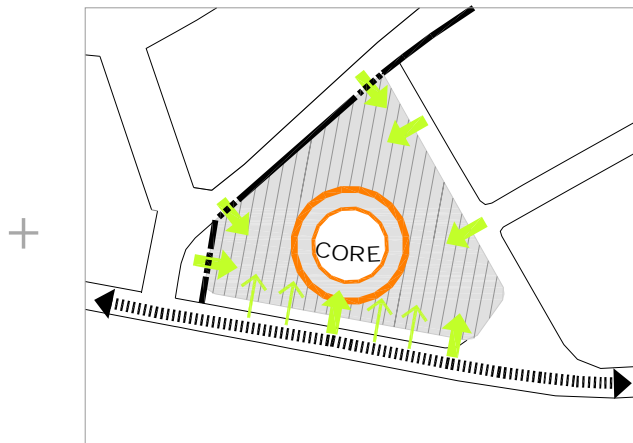

CORE CONTINUIDAD

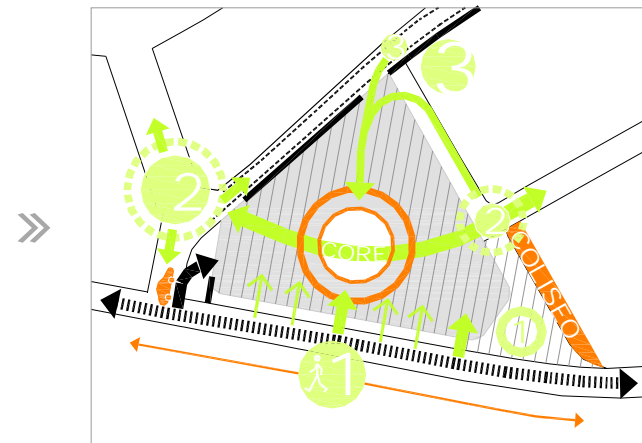

CONTINUIDAD POR SUPERPOSICIÓN DE 3 ESTRATOS

ANÁLISIS DE LA ACTUACIÓN



ACTIVACIÓN DE NODOS

+

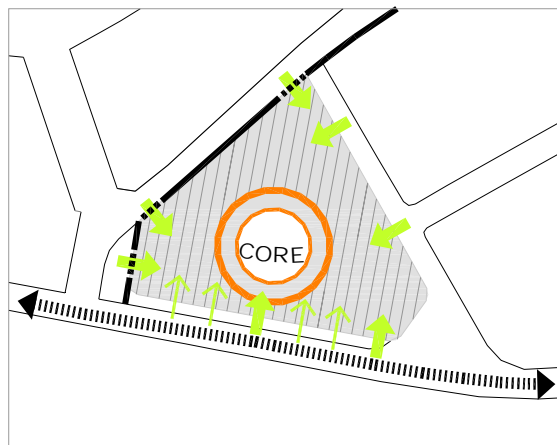

CORE CONTINUIDAD

»

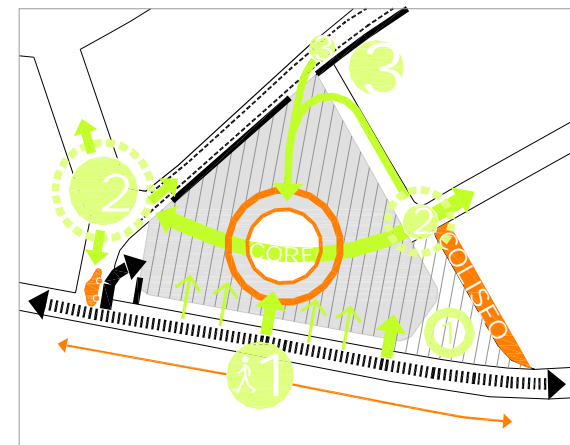

CONTINUIDAD POR SUPERPOSICIÓN DE 3 ESTRATOS

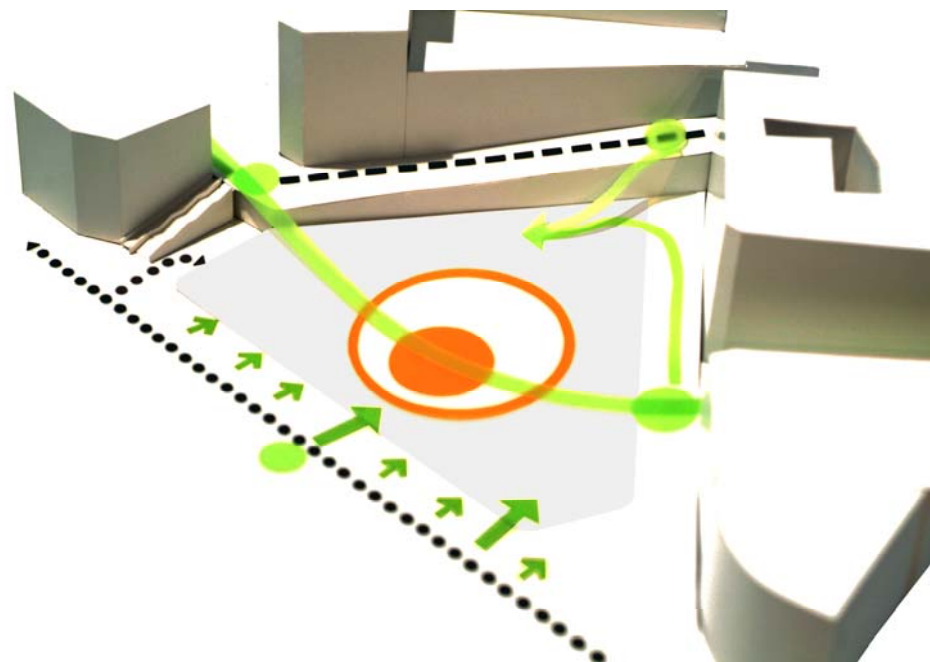
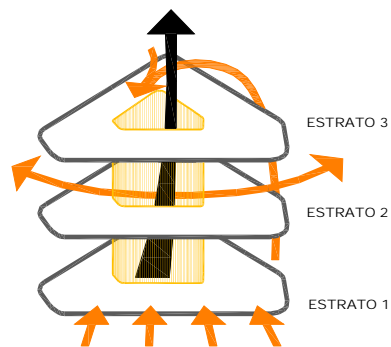
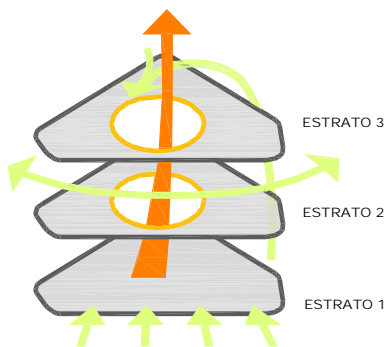

PROPUESTA ACTUACION

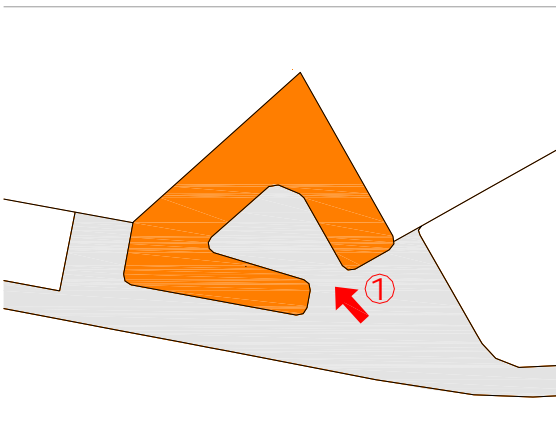

PLANTA SEMISOTANO

+

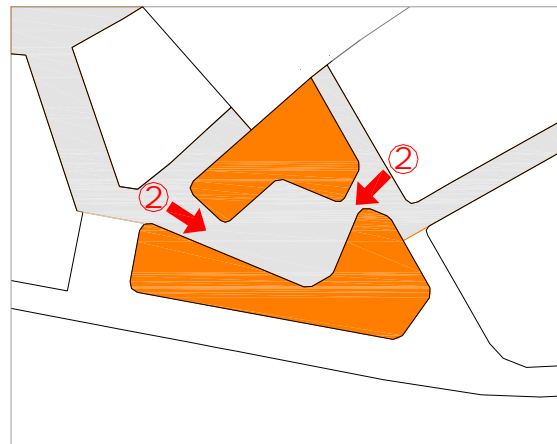

PLANTA BAJA

+

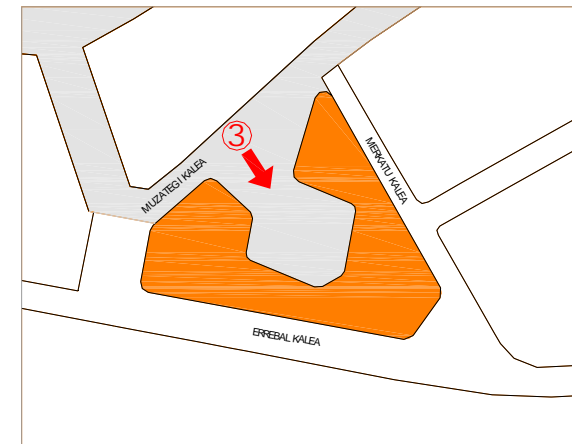

PLANTA PRIMERA

PROPUESTA ACTUACION

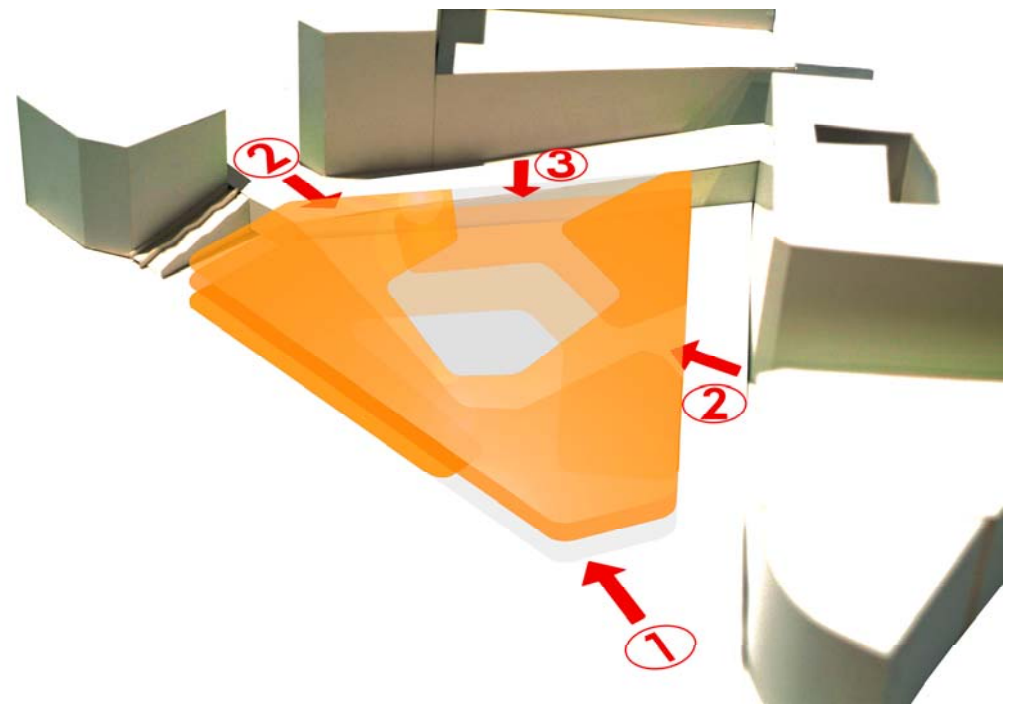
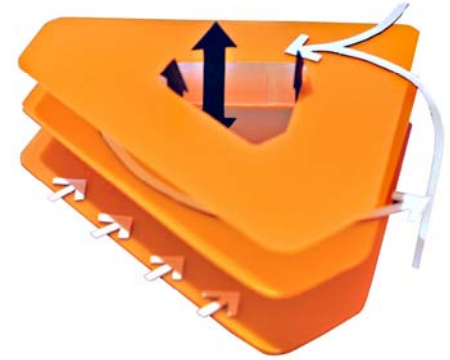

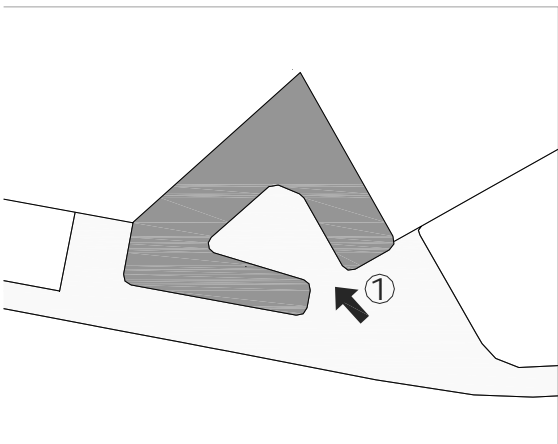
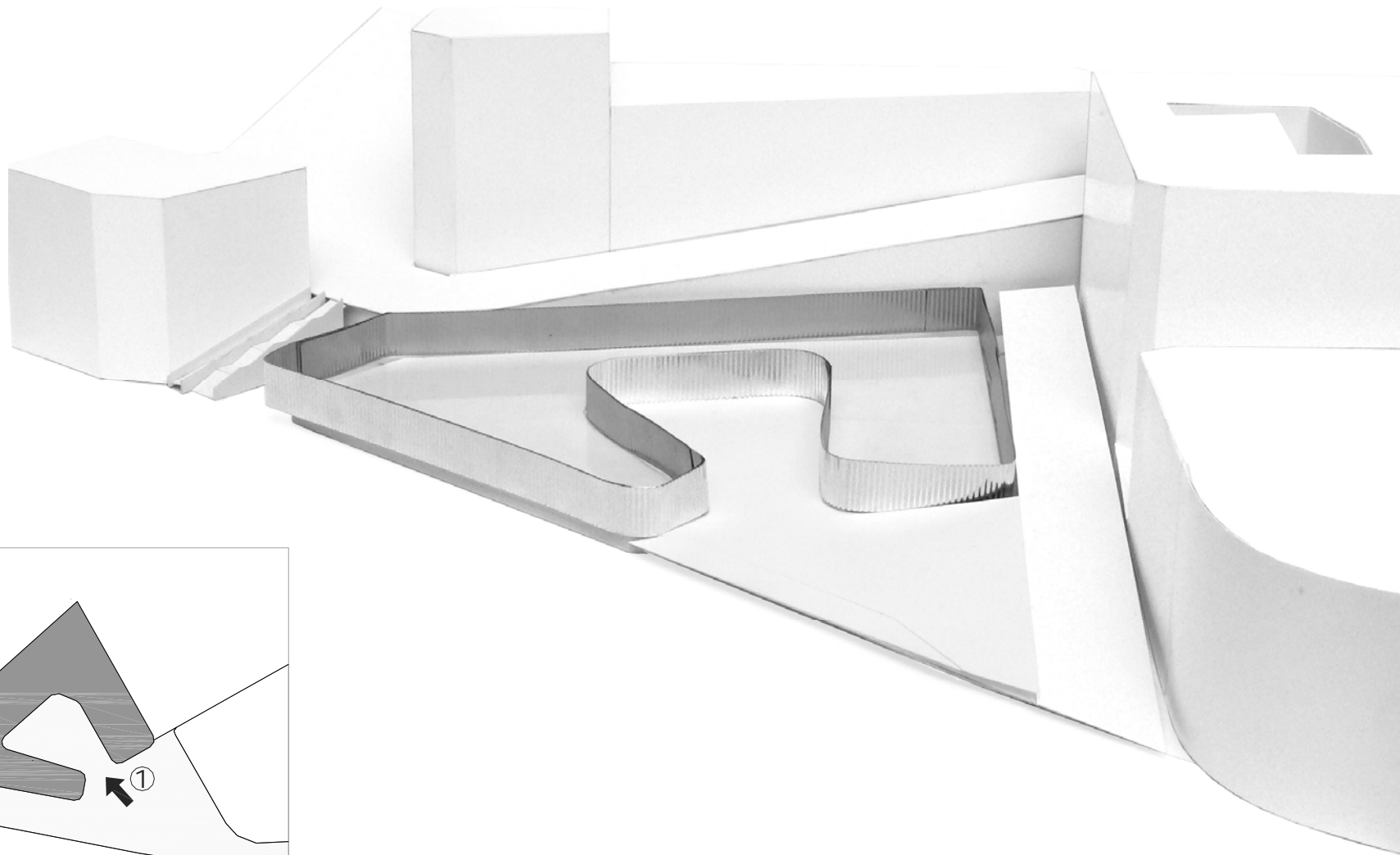

PLANTA SEMISOTANO

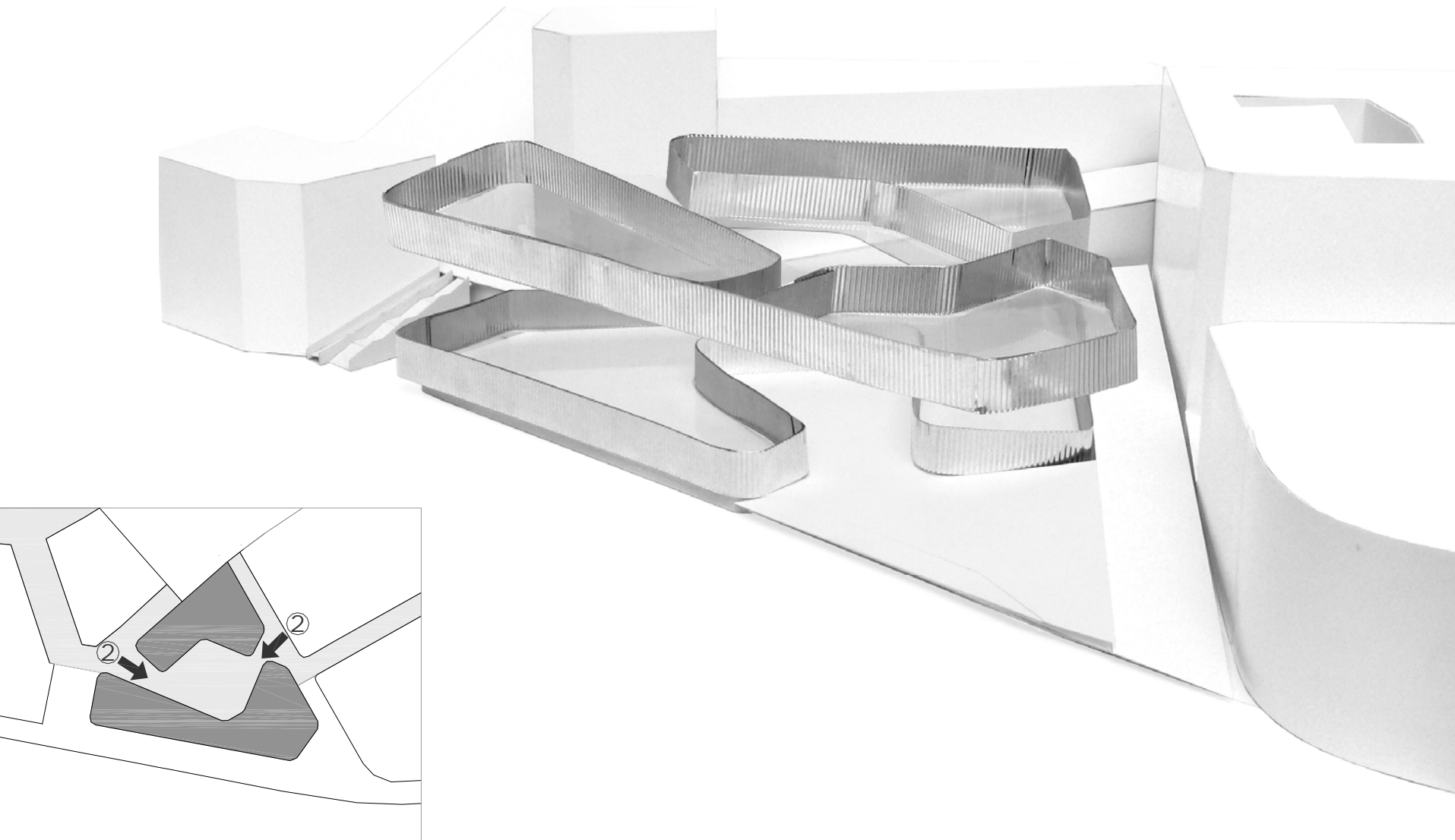

PLANTA BAJA

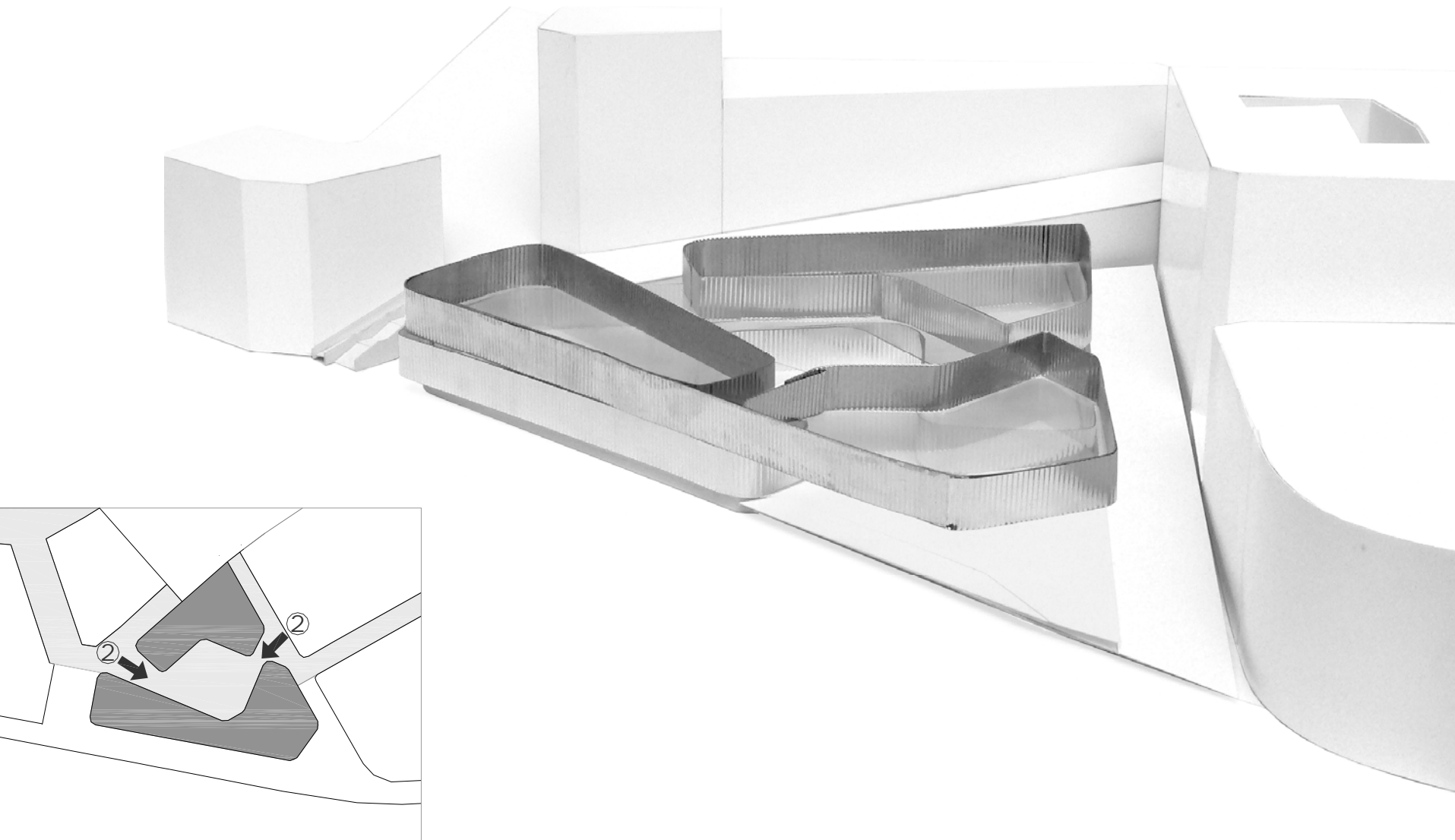

PLANTA BAJA

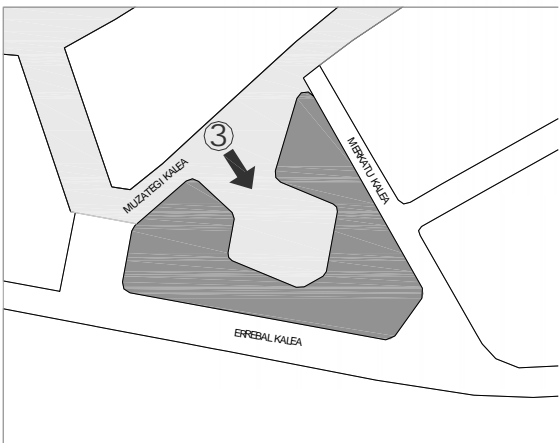
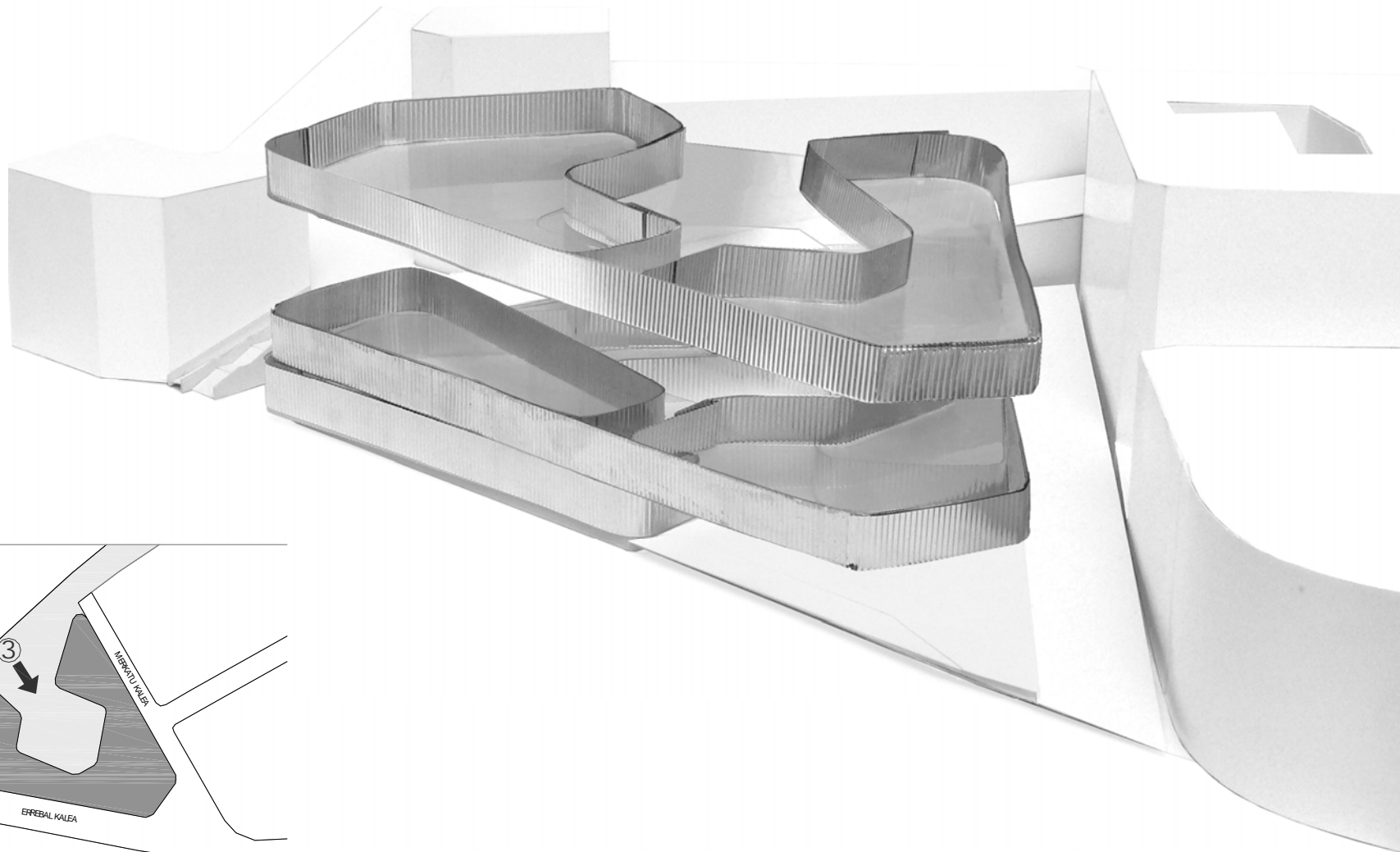

PLANTA PRIMERA

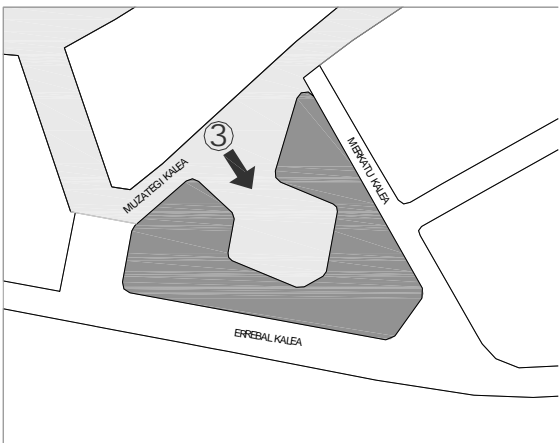
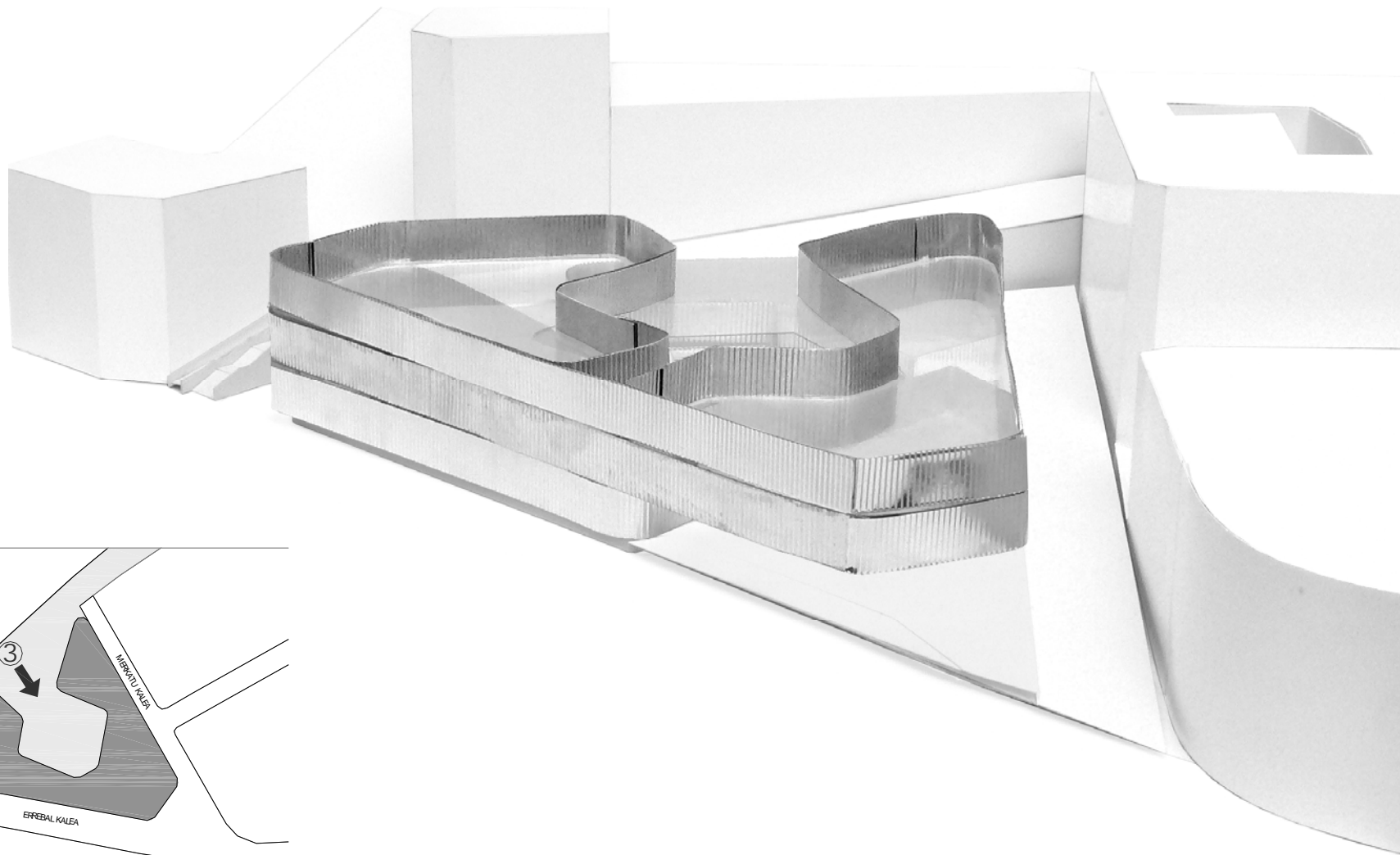

PLANTA PRIMERA

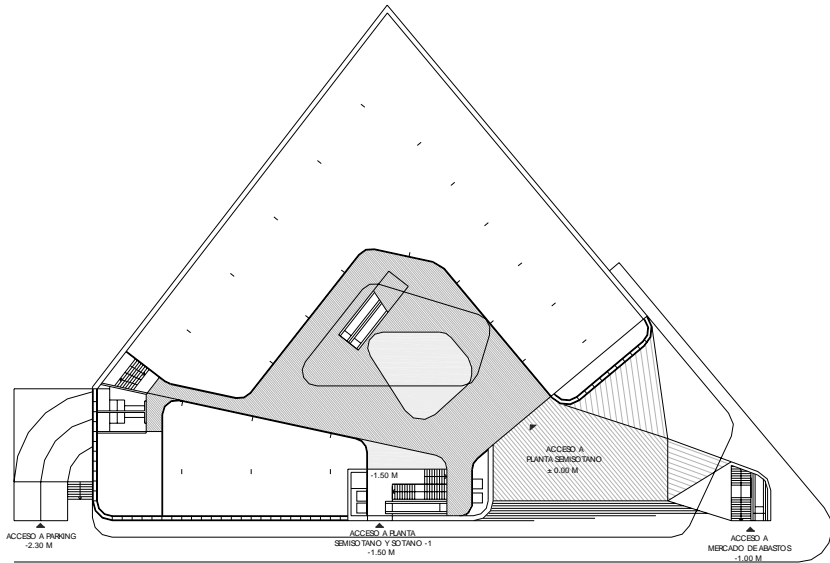

PLANTA SEMISÓTANO. NIVEL ± 0.00

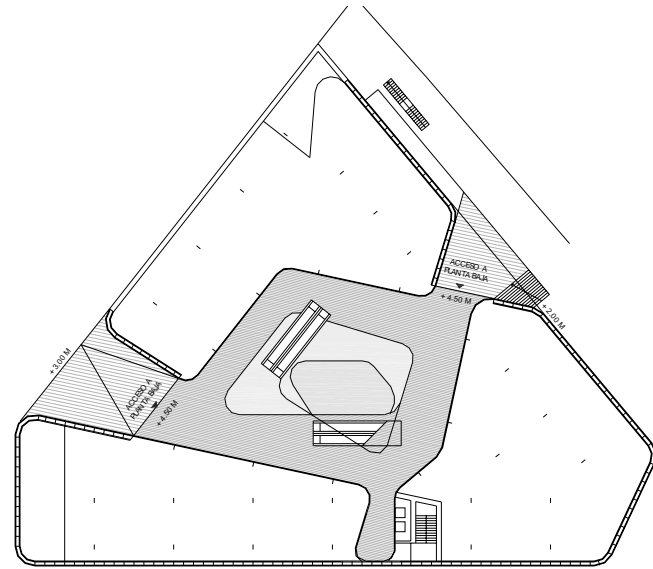

PLANTA BAJA. NIVEL + 4.50

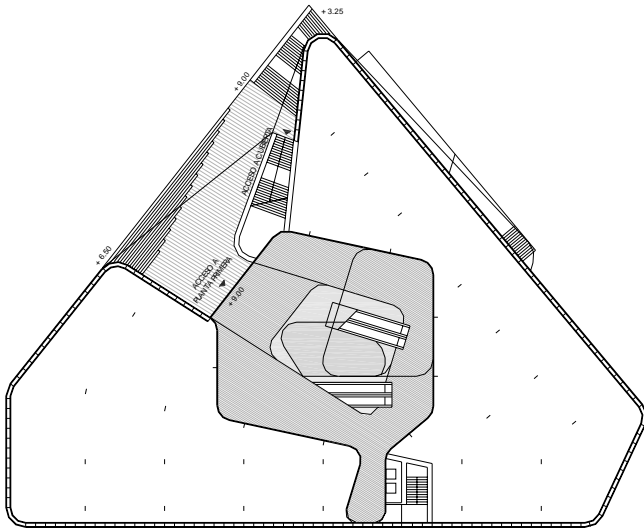

PLANTA PRIMERA. NIVEL + 9.00

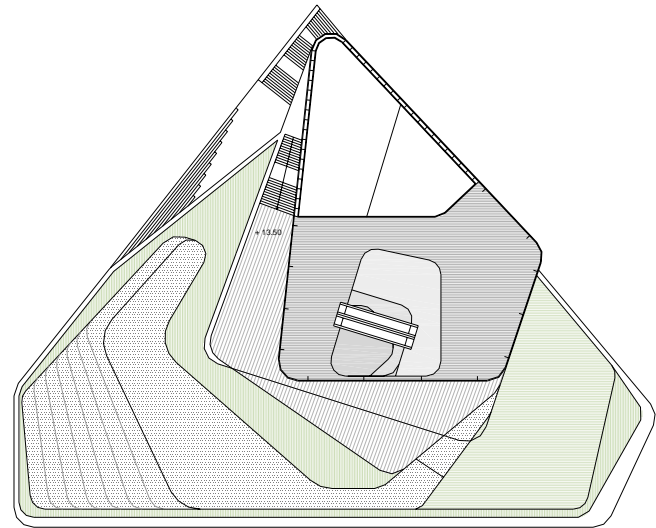

PLANTA SUPERIOR. NIVEL + 13.50



PLANTA SOTANO -1. NIVEL -5.00

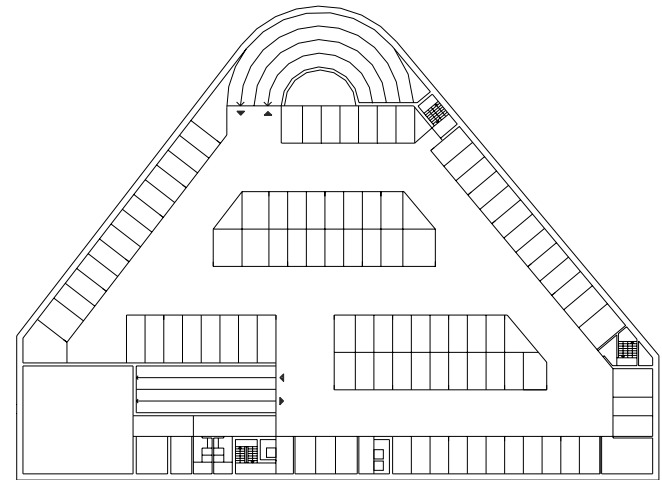

PLANTA SOTANO -2. NIVEL -8.00

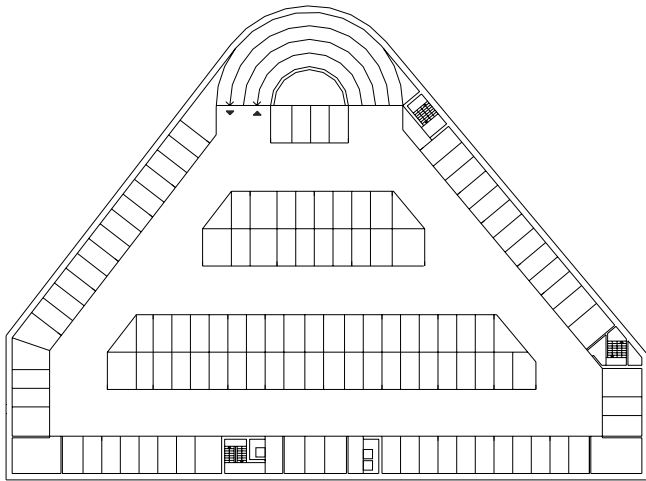

PLANTA SOTANO -3. NIVEL -11.00

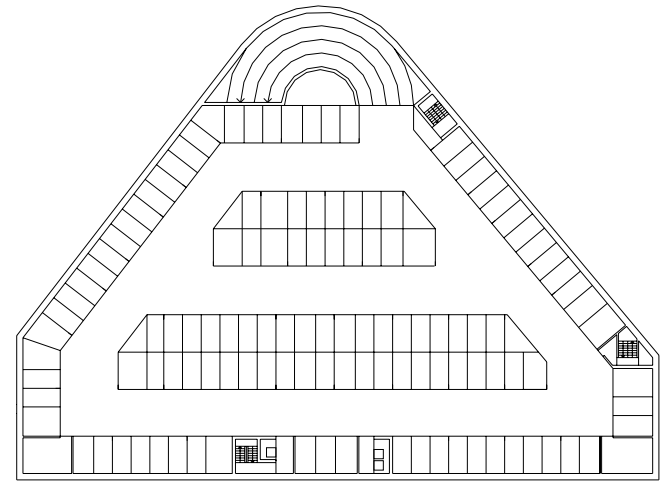

PLANTA SOTANO -4. NIVEL -14.00

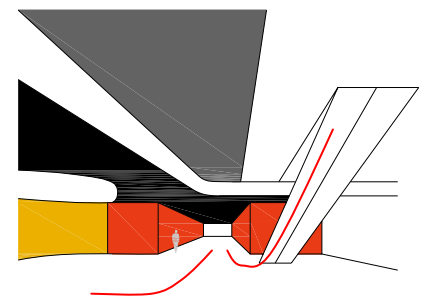
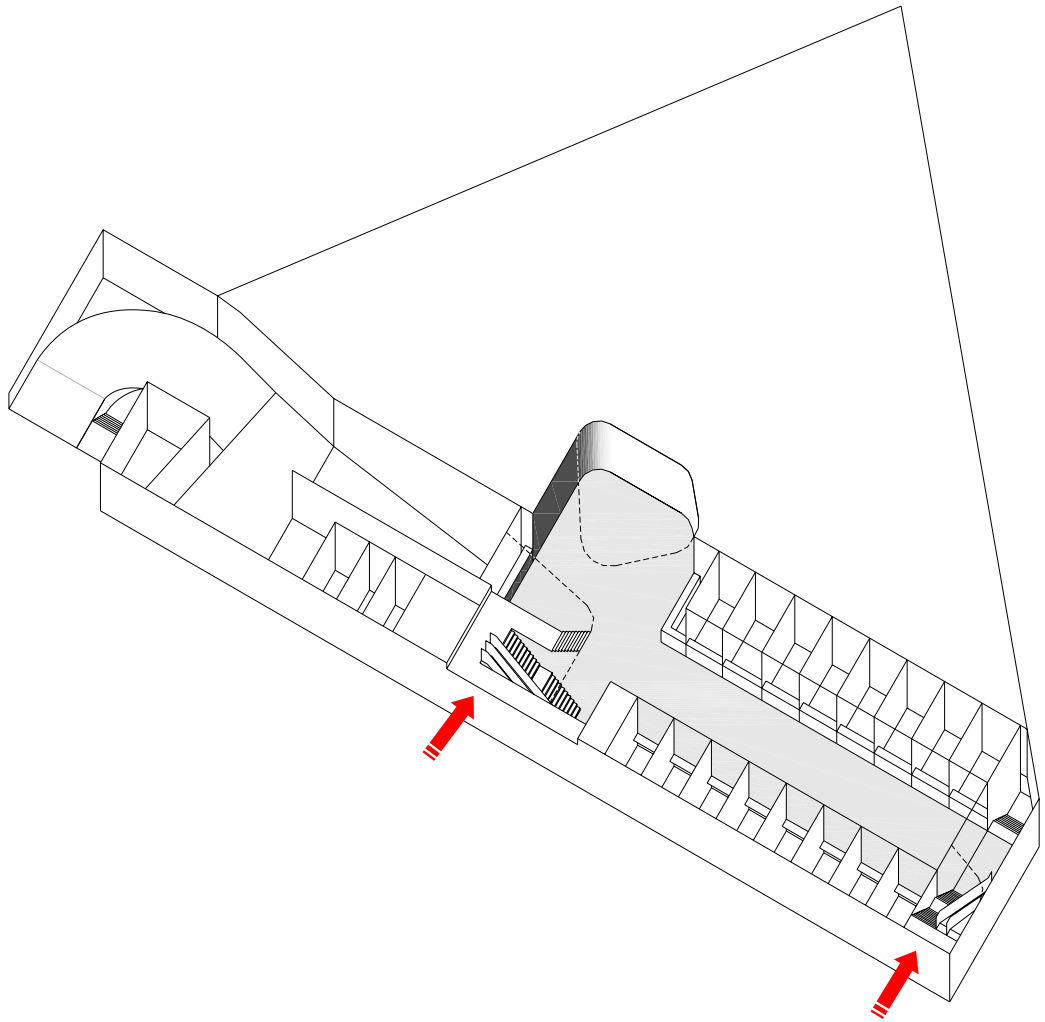

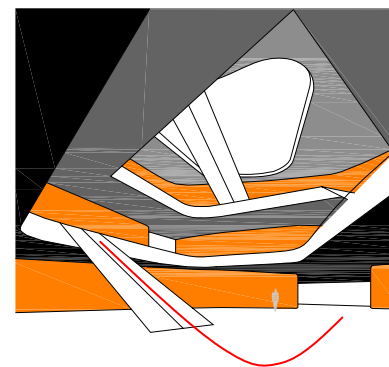
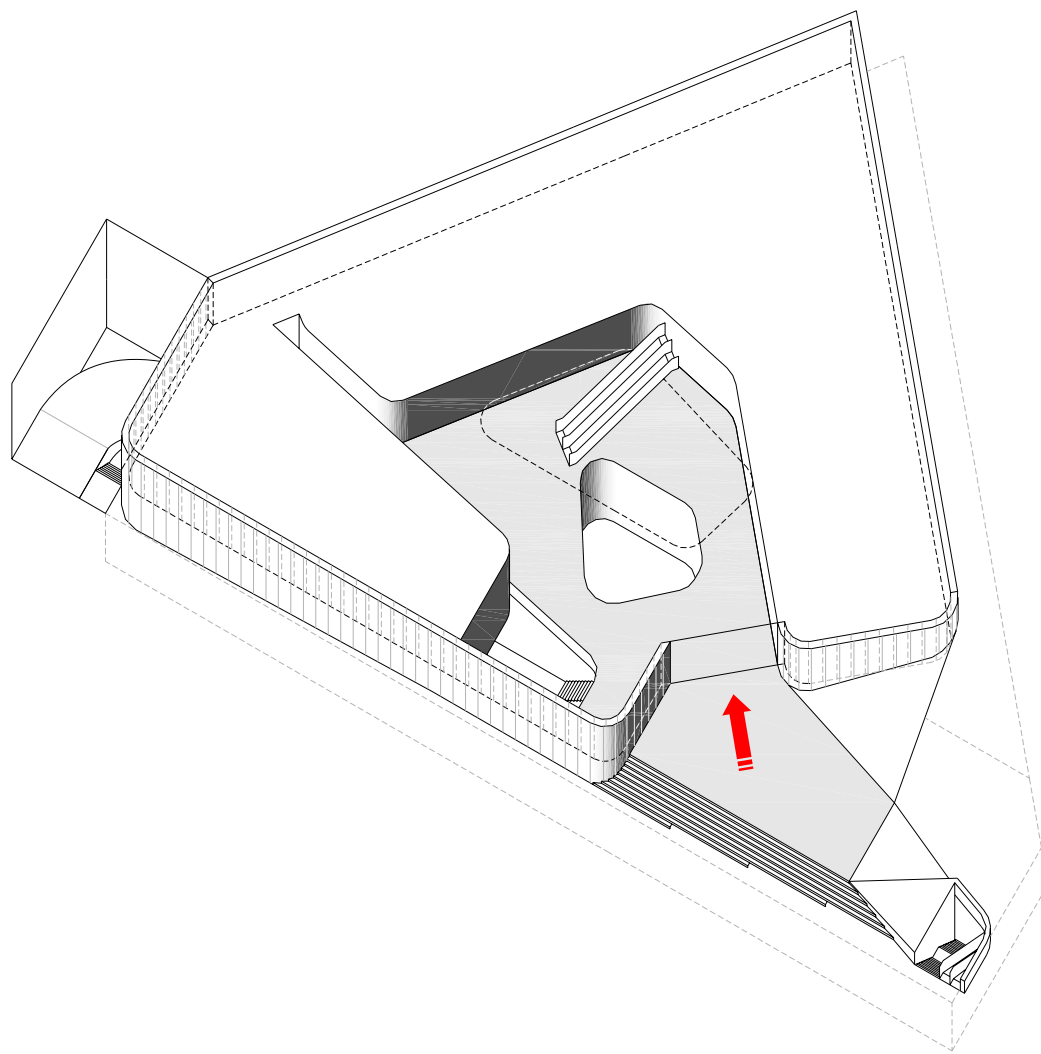

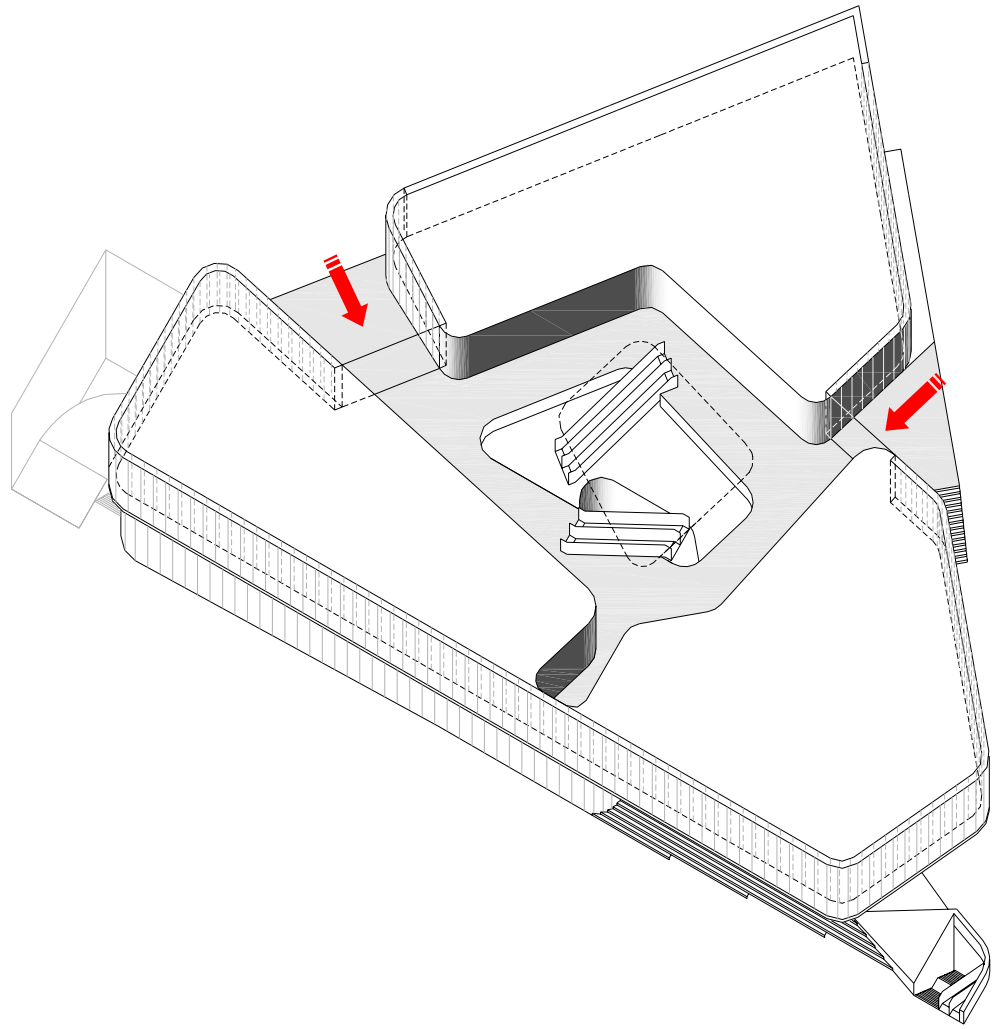

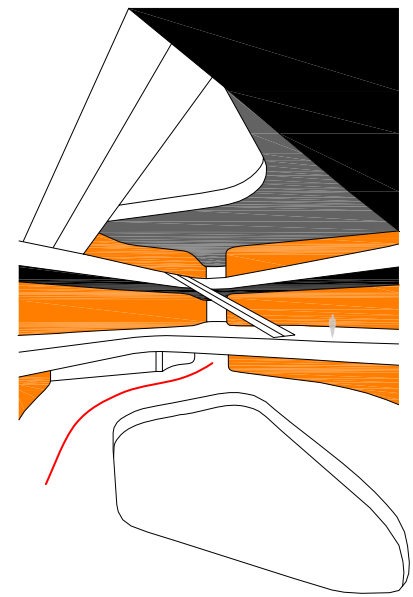
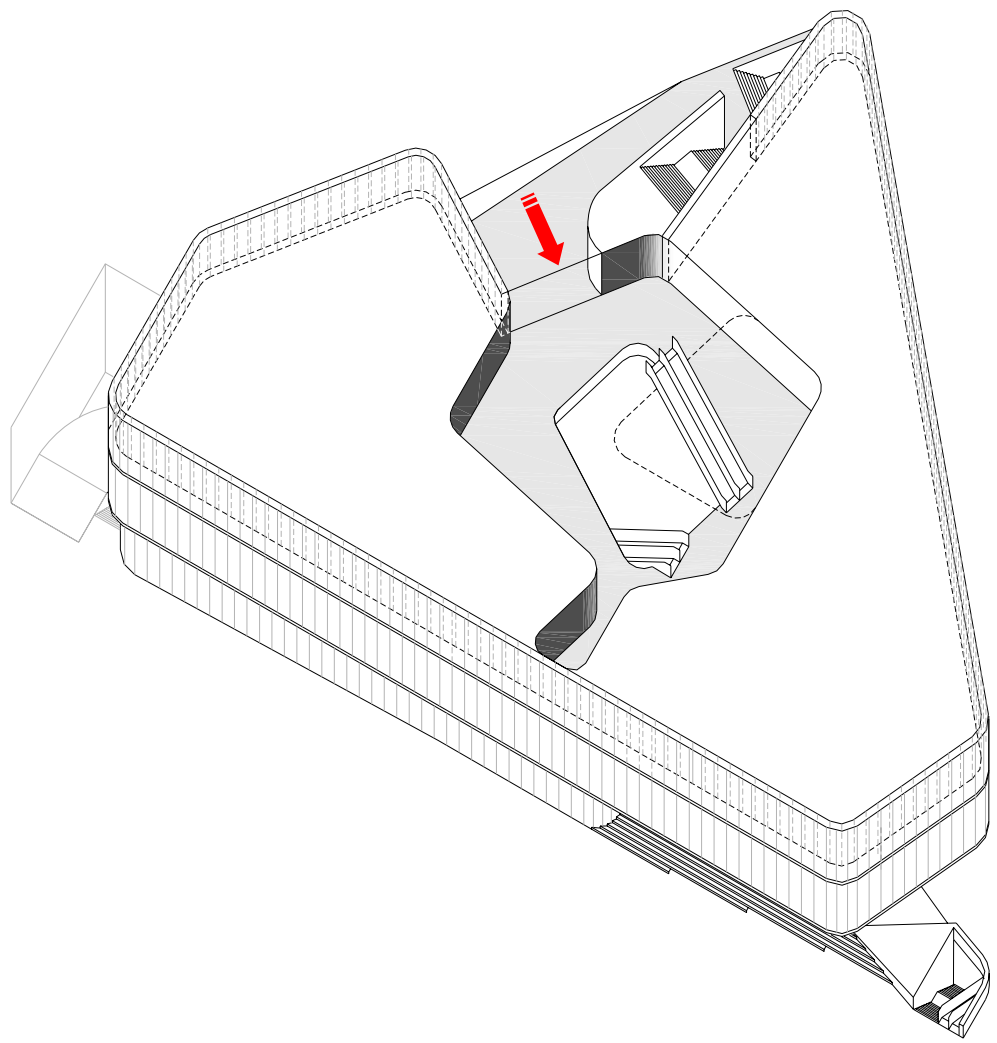

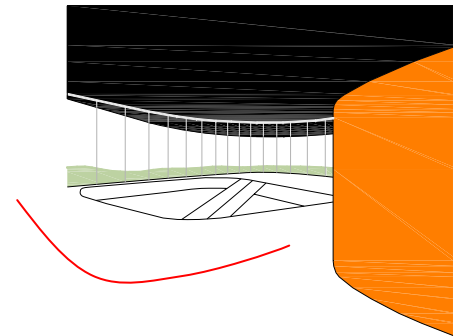
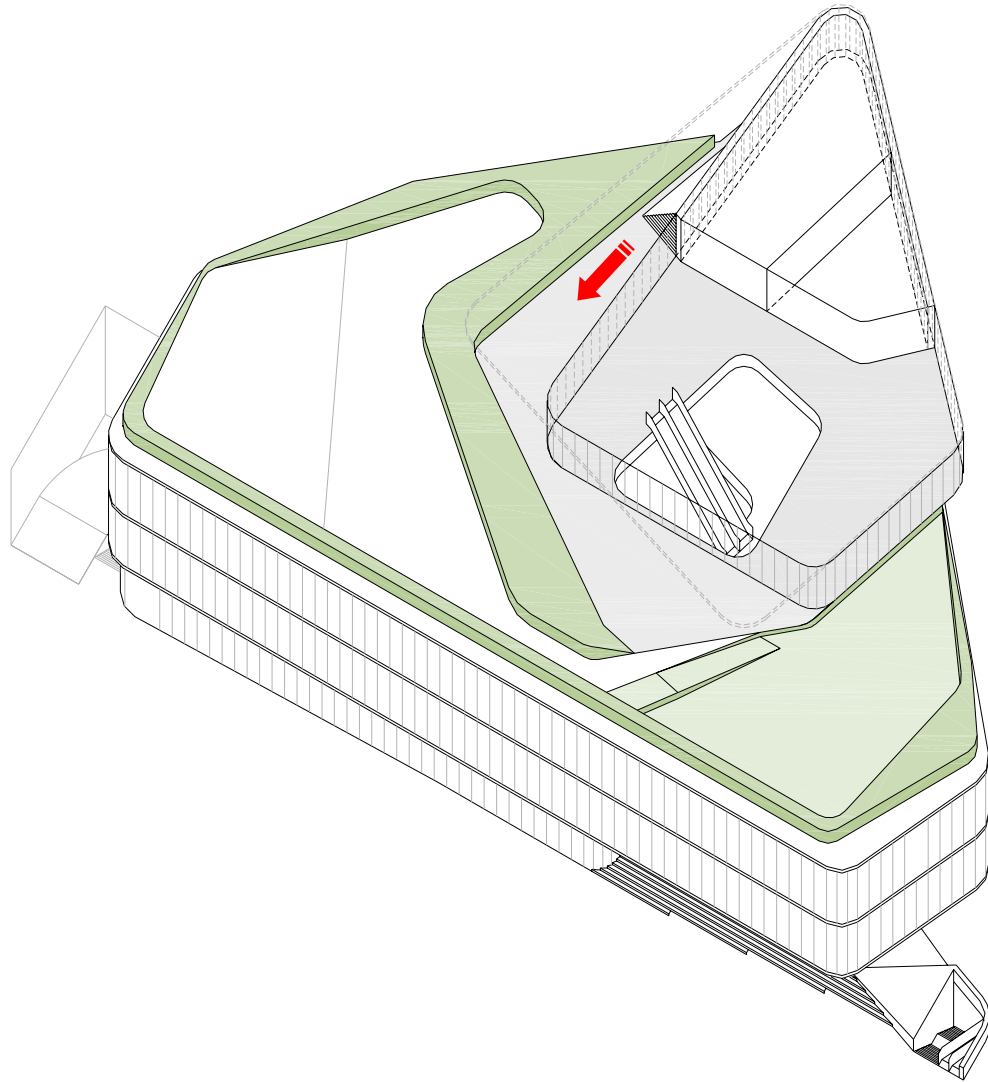

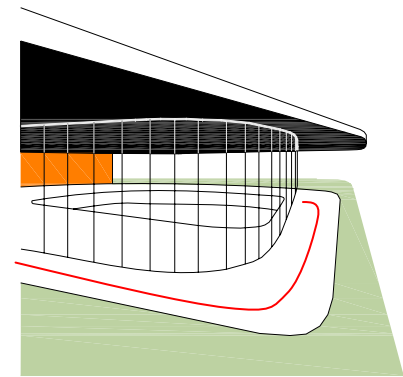
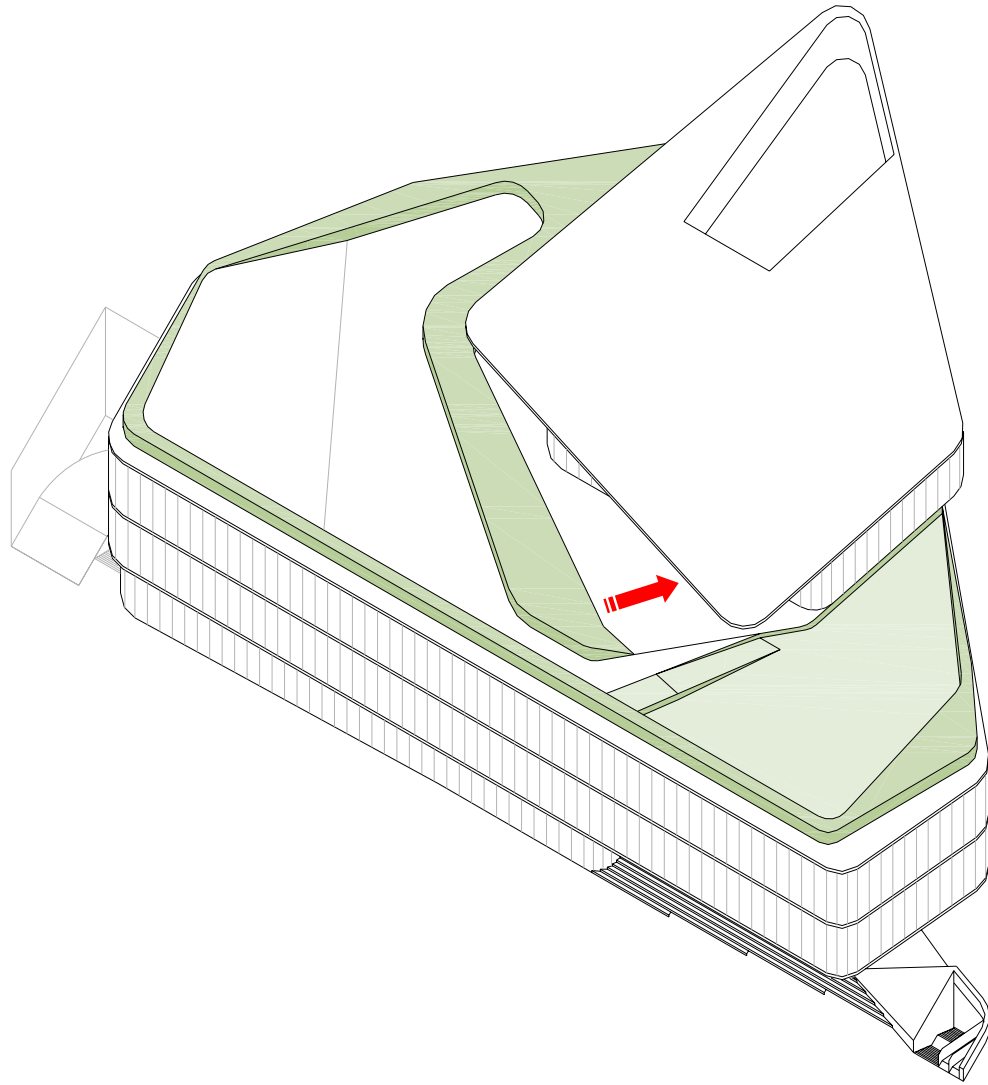



▽ +17.25.m
 ▽ +13.50.m
 ▽ +9.00.m
 ▽ +4.50.m
 ▽ +0.00.m

ALZADO ERREBAL KALEA

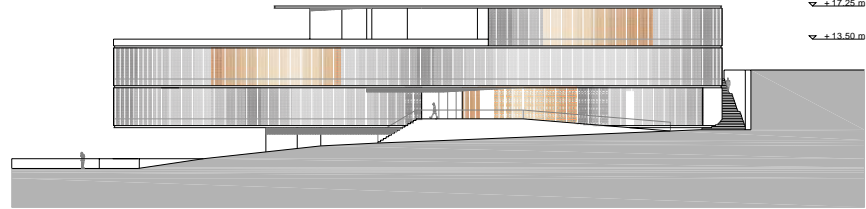

▽ +17.25.m
 ▽ +13.50.m

ALZADO MERKATU KALEA

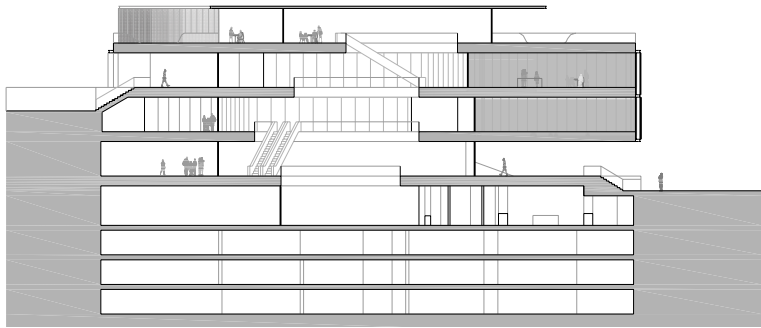

▽ +17.25.m
 ▽ +13.50.m
 ▽ +9.00.m
 ▽ +4.50.m
 ▽ +0.00.m
 ▽ -5.00.m
 ▽ -8.00.m
 ▽ -11.00.m

SECCIÓN POR CORE

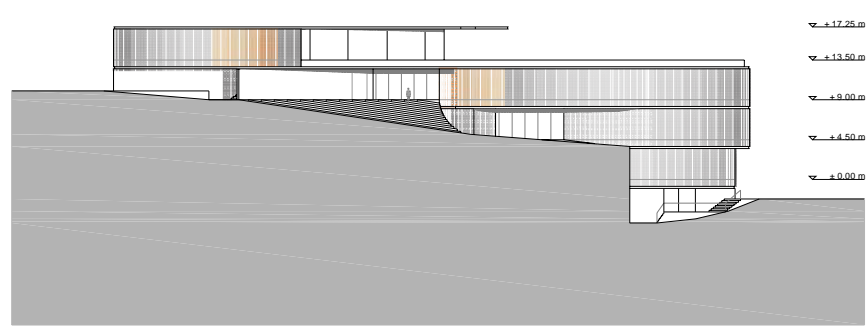

▽ +17.25.m
 ▽ +13.50.m
 ▽ +9.00.m
 ▽ +4.50.m
 ▽ +0.00.m

ALZADO MUZATEGI KALEA

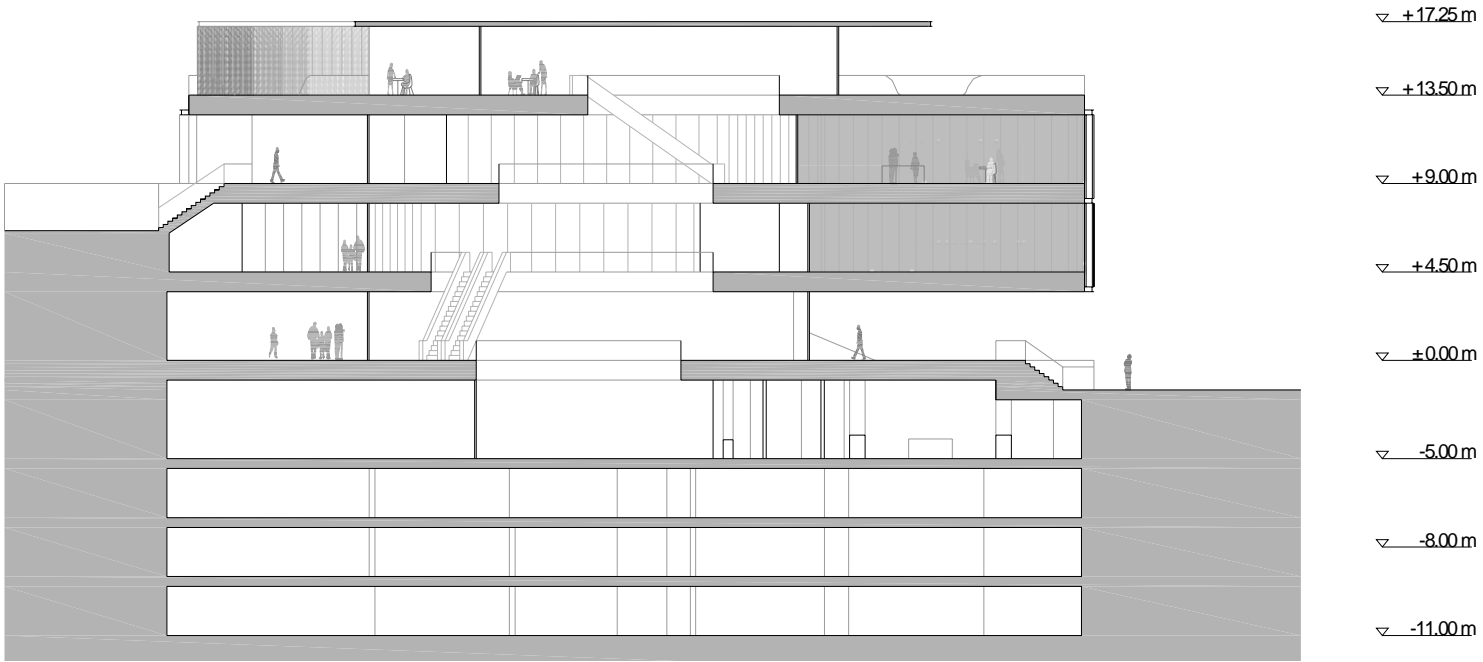

SECCIÓN POR CORE

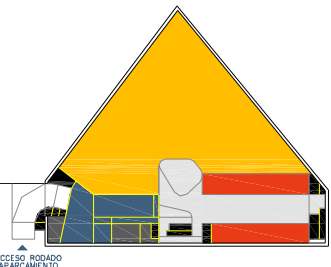

PLANTA SOTANO -1

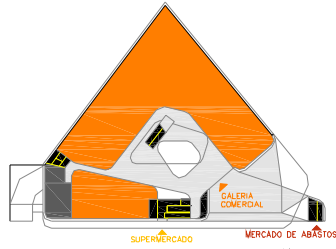

PLANTA SEMISOTANO

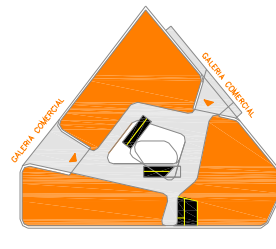

PLANTA BAJA

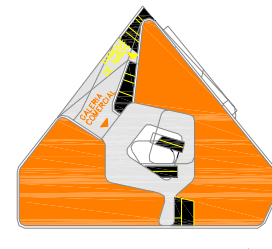

PLANTA PRIMERA

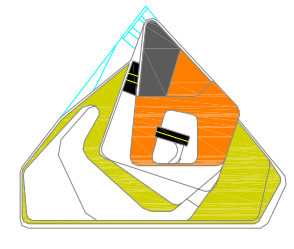

PLANTA CUBIERTA
ESQUEMA DE USOS

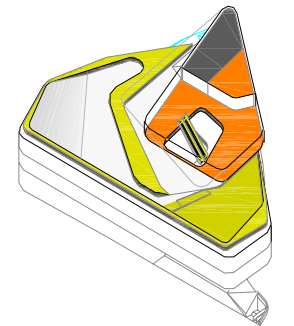
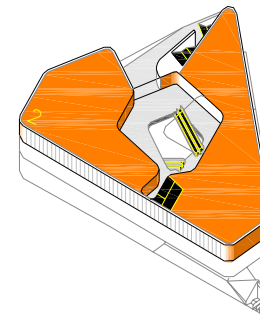
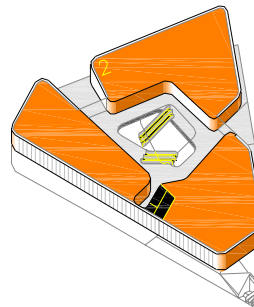
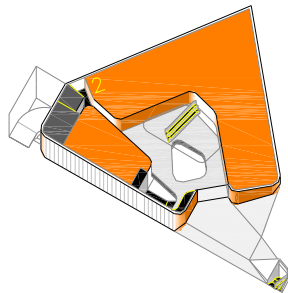
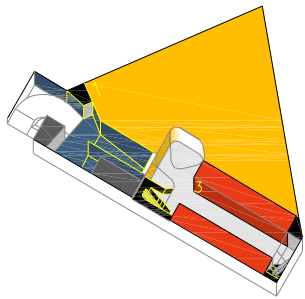

AXONOMETRIAS DE PROGRAMA
 ■ SUPERMERCADO ■ GALERIA COMERCIAL ■ MERCADO DE ABASTOS ■ INSTALACIONES + SERVICIOS ■ MALL + CIRCULACIONES
 M2nc = METROS CUADRADOS NO COMPUTABLES
 M2c = METROS CUADRADOS COMPUTABLES

	SUPERMERCADO (GLA)	GALERIA COMERCIAL (GLA)	MERCADO DE ABASTOS	INSTALAC+ SERVICIOS	MALL + CIRCULACIONES	TOTAL M2 COMPUTABLES	PARKING	TOTAL M2 CONSTRUIDOS
PLANTA CUBIERTA	-	518,75 M2c	-	-	-	518,75 M2c	-	518,75 M2
PLANTA PRIMERA	-	1858,31 M2c	-	-	466,47 M2c	2324,78 M2c	-	2324,78 M2
PLANTA BAJA	-	1906,72 M2c	-	-	546,73 M2c	2453,45 M2c	-	2453,45 M2
PLANTA SEMISOTANO	-	1545,43 M2c	-	70,86M2nc /30,17M2c	575,23 M2c	2150,83 M2c	-	2221,69 M2
PLANTA SOTANO 1	1833,66 M2c	-	599,50 M2c	100,61 M2c	246,64 M2c	2780,41 M2c	220,06 M2nc	3000,47 M2
PLANTA SOTANO 2	-	-	-	338,21 M2nc	-	-	2928,49 M2nc	3266,70 M2
PLANTA SOTANO 3	-	-	-	63,36 M2nc	-	-	3094,58 M2nc	3157,94 M2
PLANTA SOTANO 4	-	-	-	63,36 M2nc	-	-	3094,58 M2nc	3157,94 M2
TOTAL M2	1833,66 M2c	5819,21 M2c	599,50 M2c	719,59M2nc/130,78M2c	2254,52 M2c	10228,22 M2c	9337,71 M2nc	20101,72 M2
7652,87 M2c								

AREAS EXT. PEATONALES
1805,26 M2
308,85 M2
256,93 M2
365,08 M2
-
-
-
-
2736,12 M2

	NORMATIVA	PROYECTO
AMBITO ACTUACION	5005,00 M2	5005,00 M2
SUP. NETA SUELO	3477,00 M2	3477,00 M2
EQUIP. PUBLICOS	1528,00 M2	1528,00 M2
SUP. EDIFICABLE	MAX: 10230,00 M2	10228,32 M2
OCUPACION P.BAJA	MAX: 2490,00 M2	2488,95 M2
OCUPACION B/R	MAX: 3457,00 M2	3457,00 M2
SERVIDUMBRE DE USO PUBLICO (C/ERREBAL)	MIN: 830,00 M2	894,78 M2

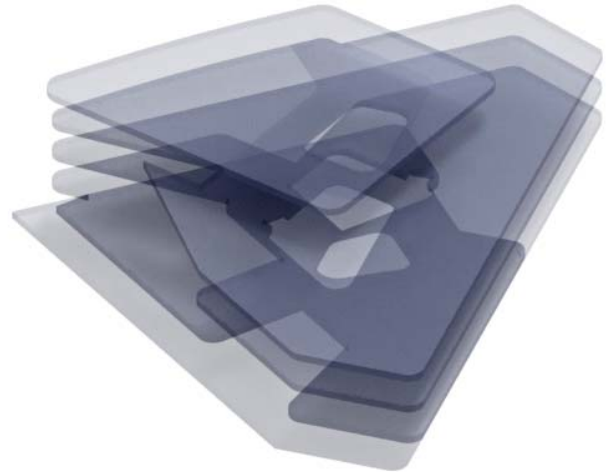
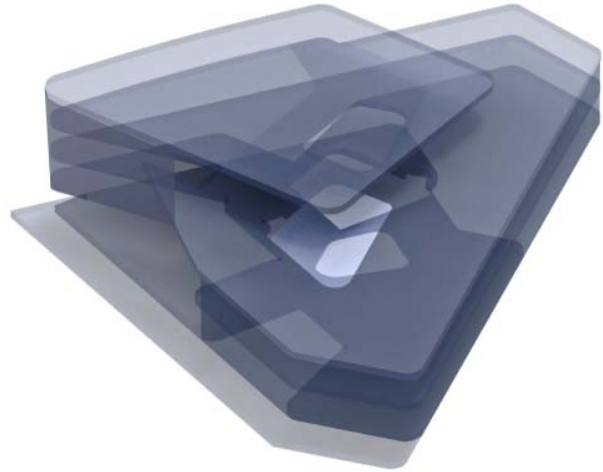
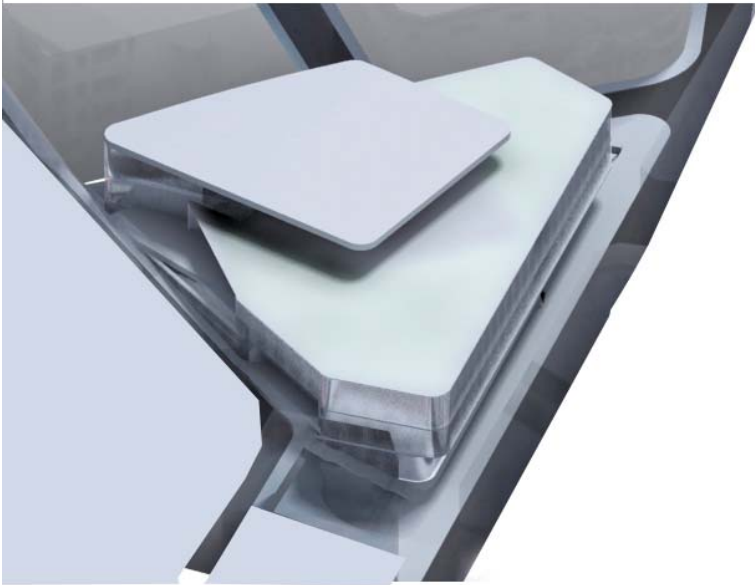

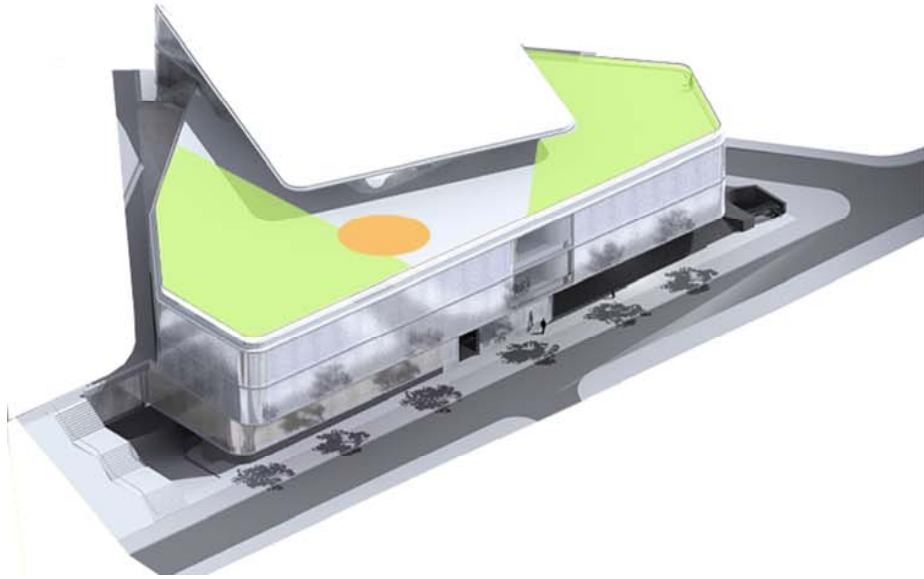







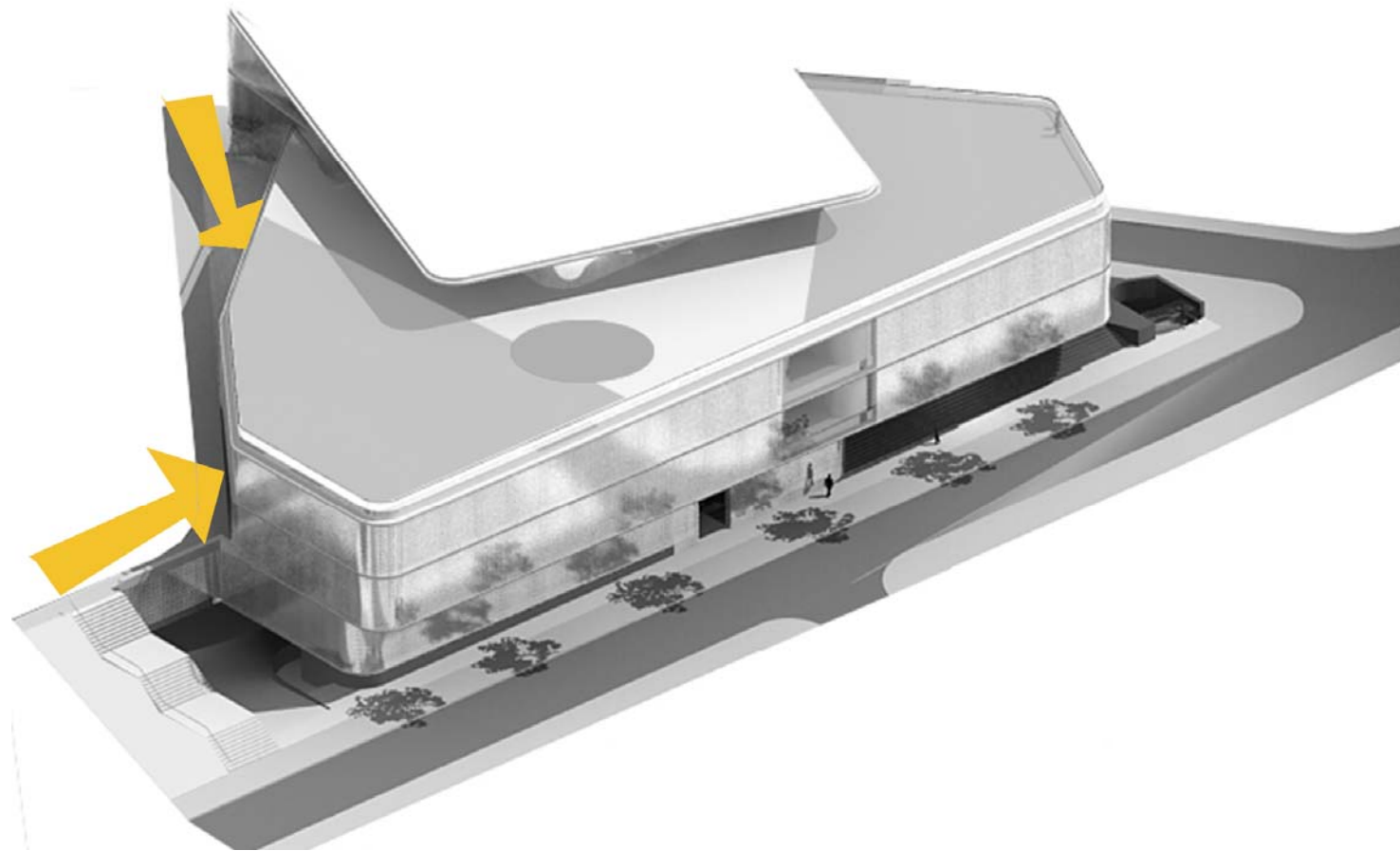







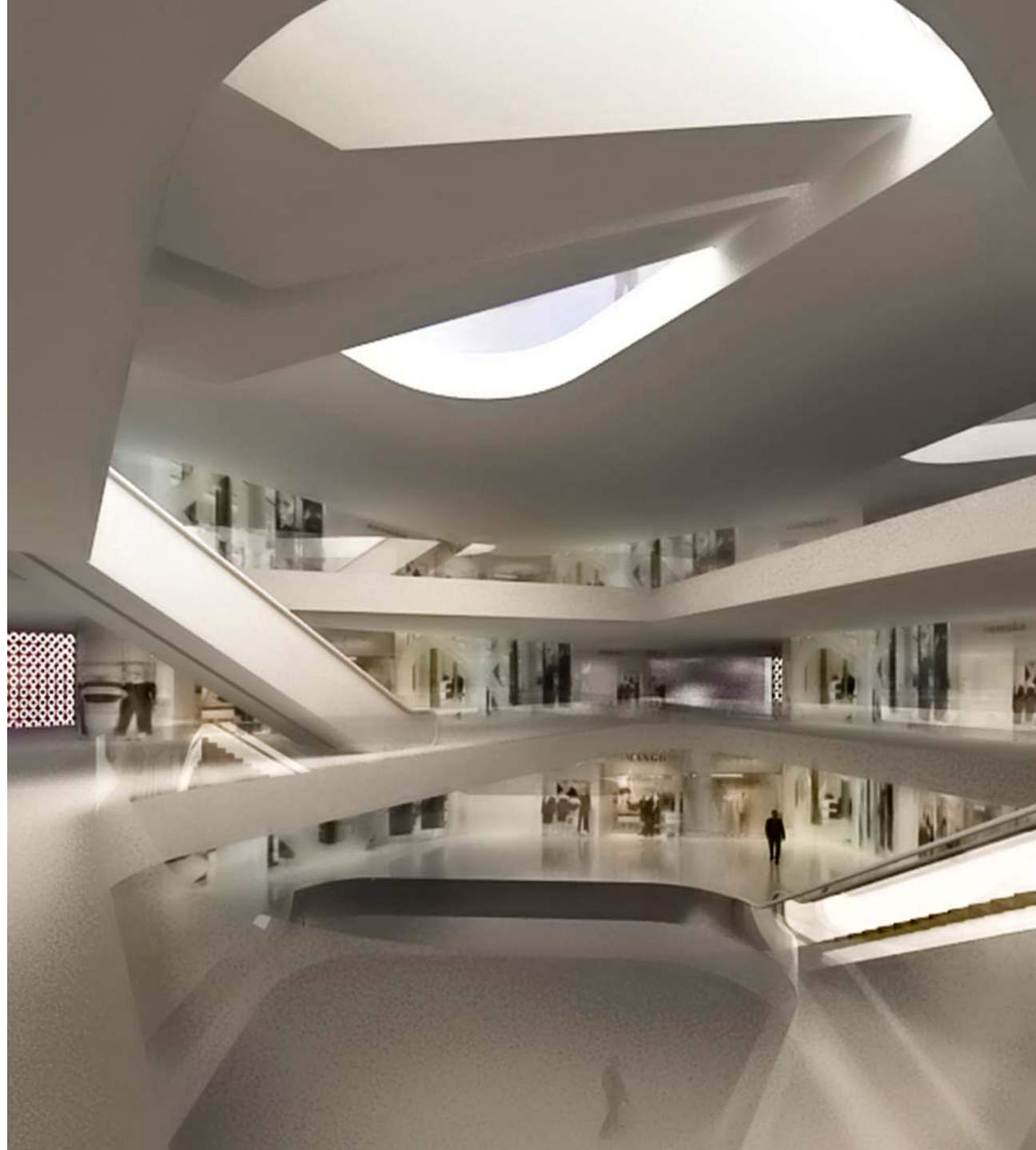

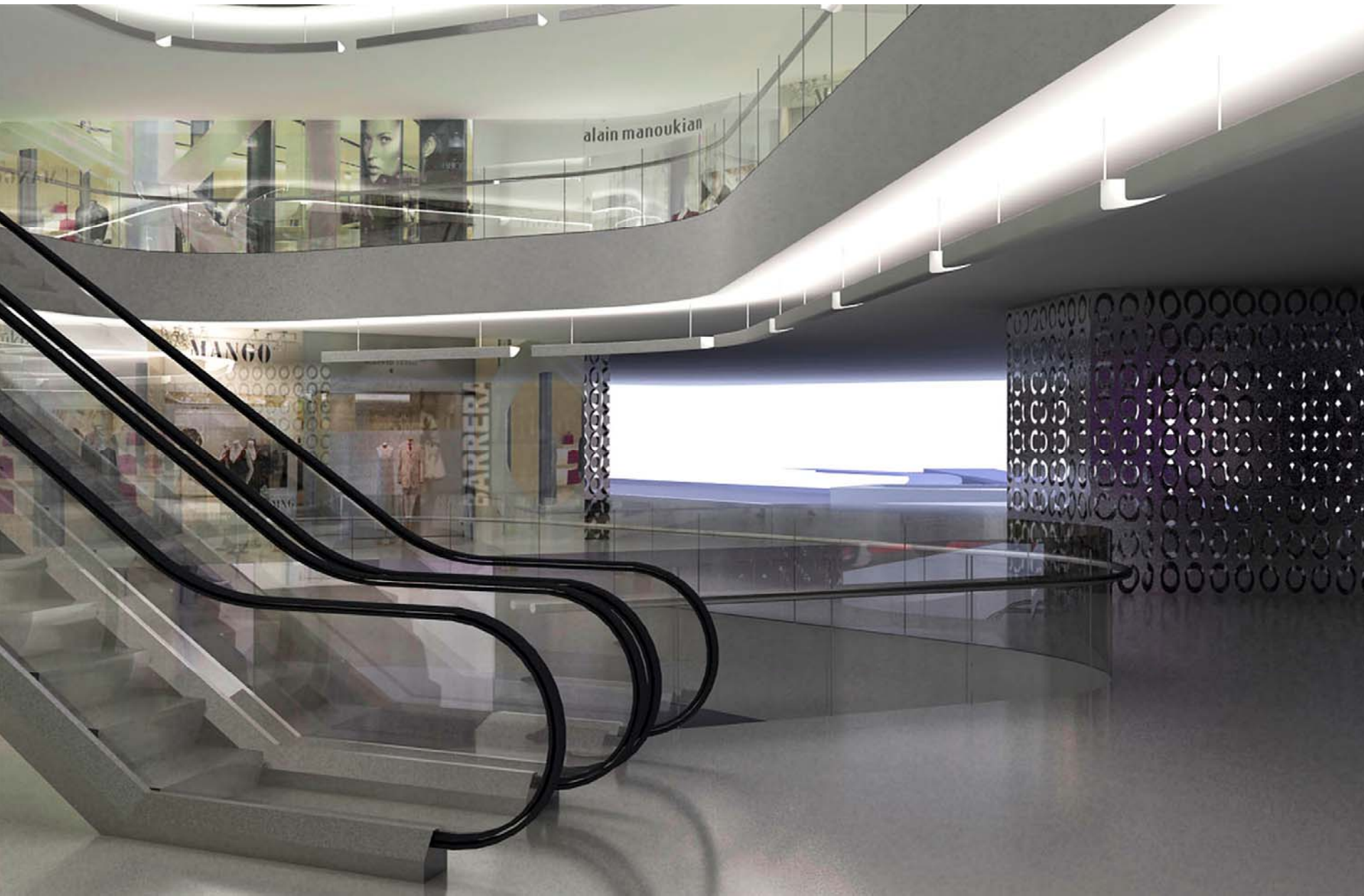

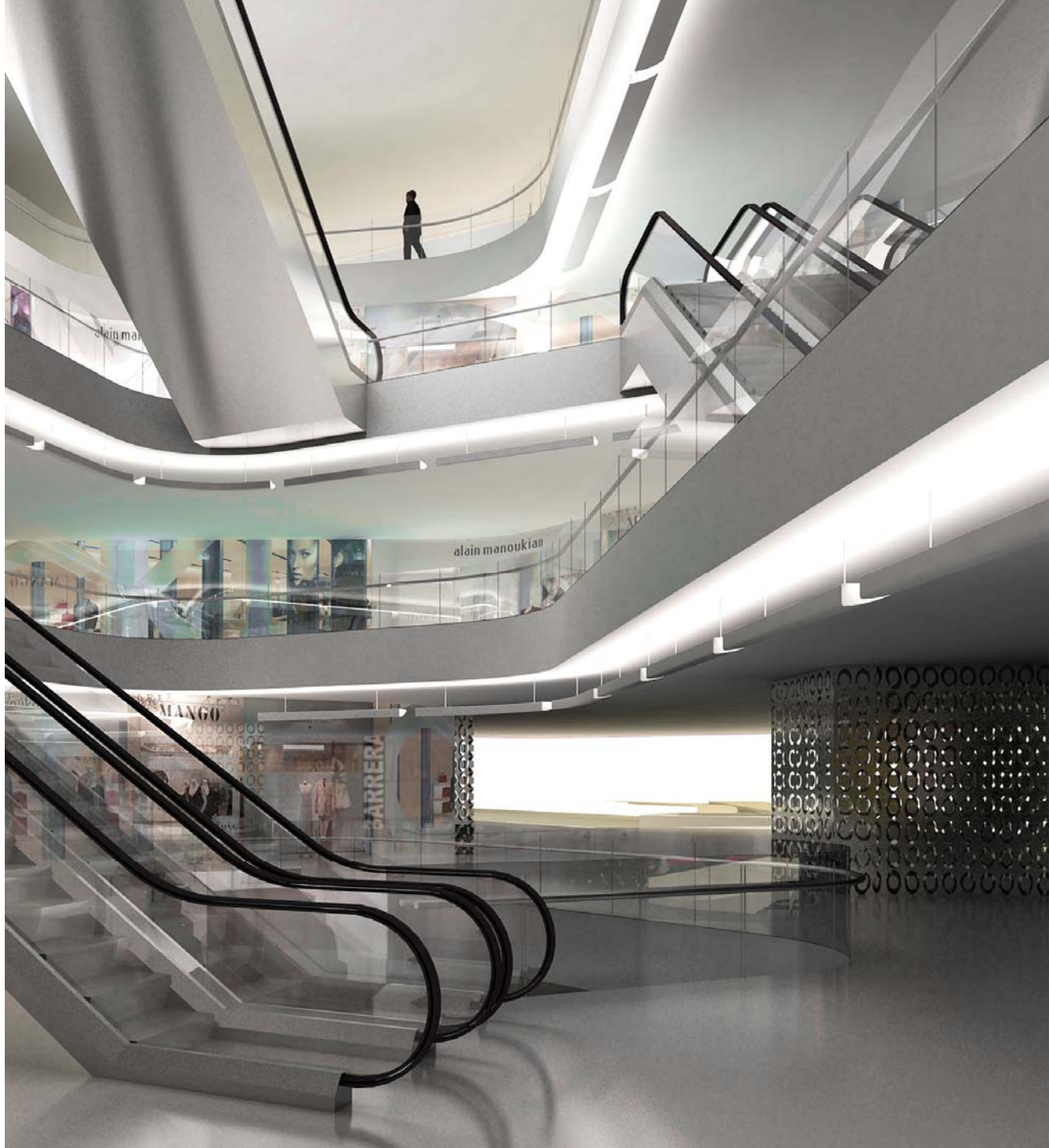

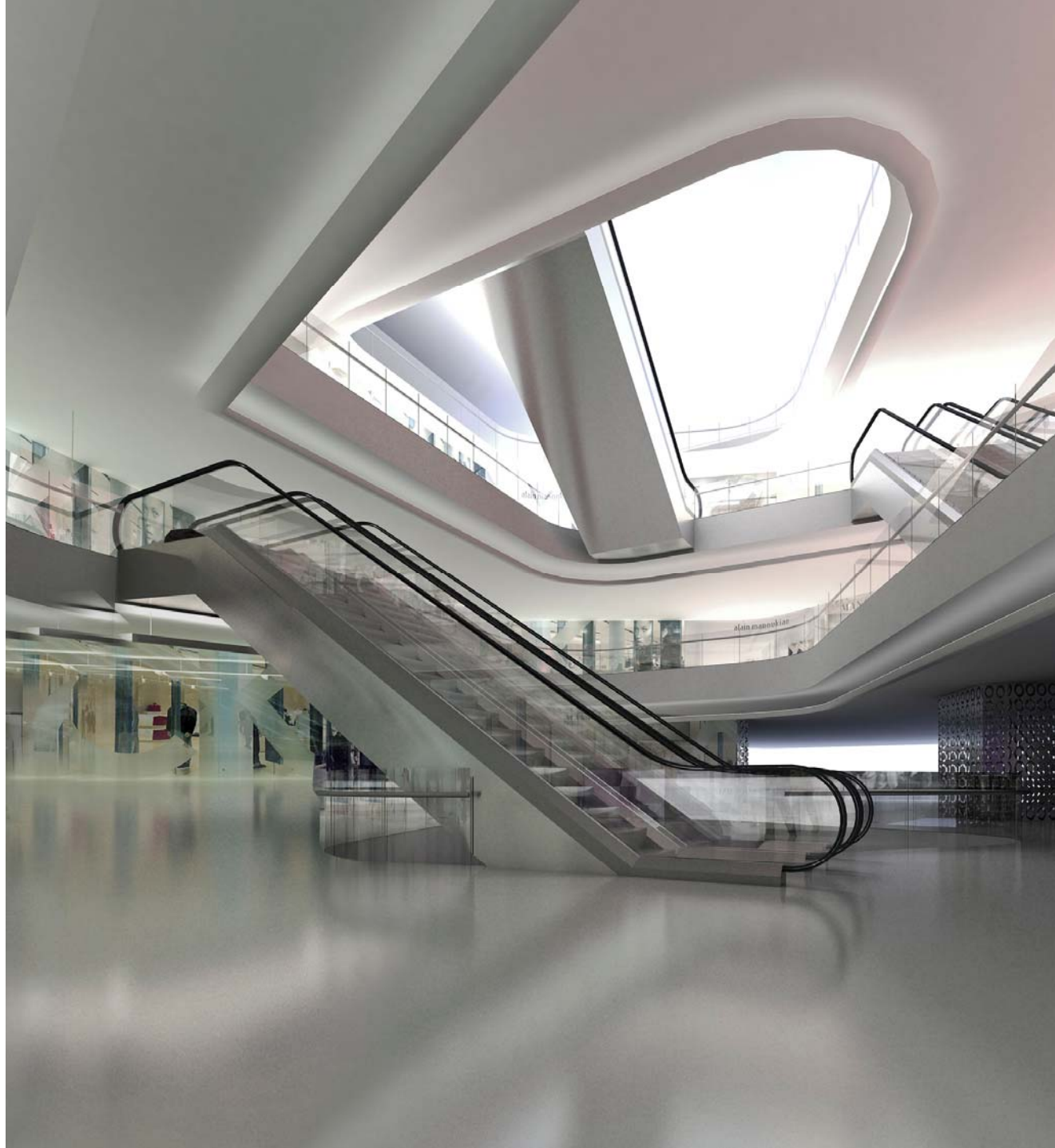









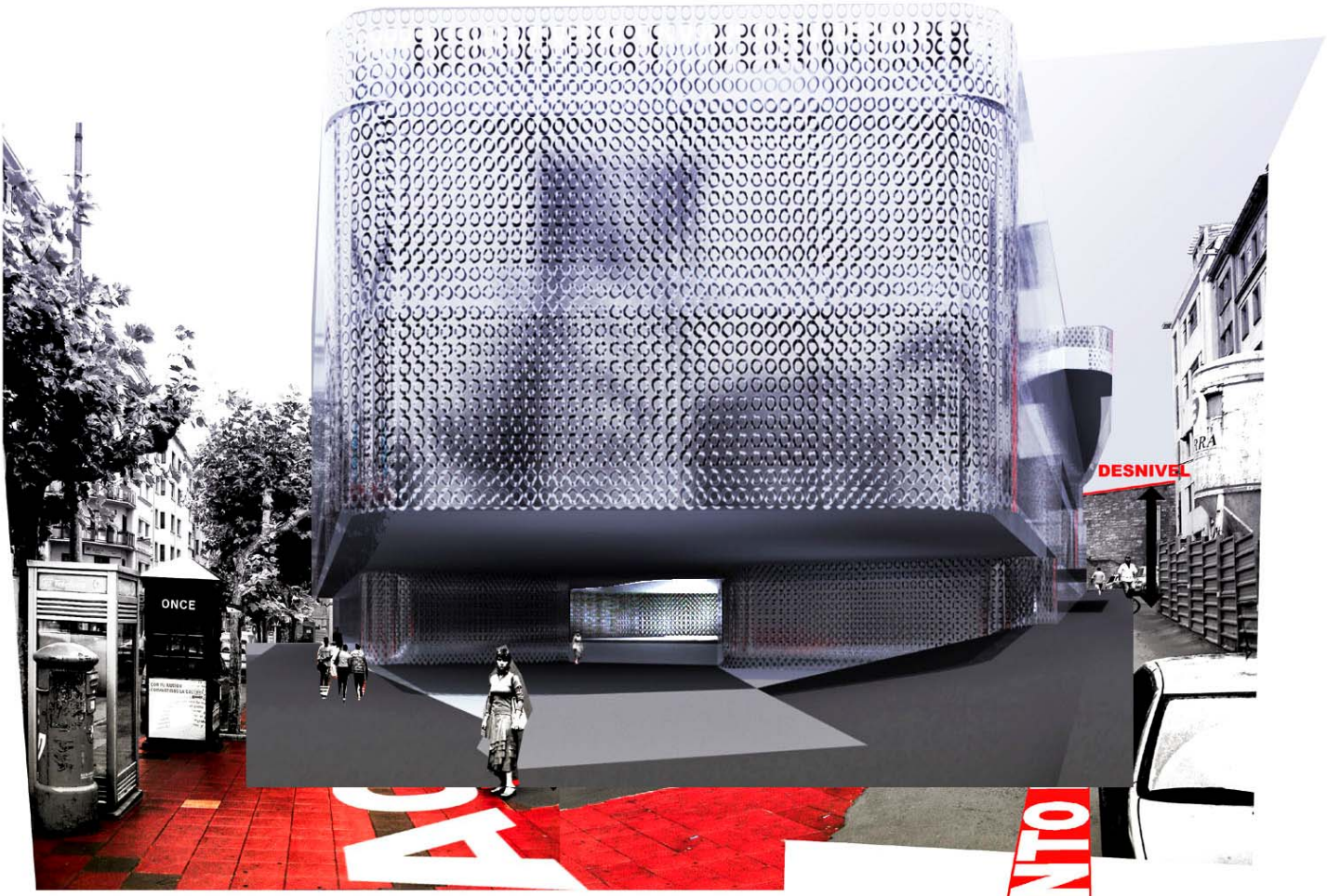

ONCE

DESNIVEL

A

PUNTO

